

# DIGITAL STATIONARY TRANSMITTER

Model: RF-TXRM 865/915

User Manual



# Manufacturer's Declaration

---

## ■ This product meets the following standards:

### ◆ Federal Communications Commission Interference Statement

Notice: The changes or modifications not expressly approved by the party responsible for compliance could void the user's authority to operate the equipment.

**FCC INFORMATION**

The Federal Communication Commission Radio Frequency Interference Statement includes the following paragraph:  
The equipment has been tested and found to comply with the limits for a Class B Digital Device, pursuant to part 15 of the FCC Rules. These limits are designed to provide reasonable protection against harmful interference in a residential installation. This equipment generates, uses and can radiate radio frequency energy and, if not installed and used in accordance with the instruction, may cause harmful interference to radio communication.  
However, there is no guarantee that interference will not occur in a particular installation. If this equipment does cause harmful interference to radio or television reception, which can be determined by turning the equipment off and on, the user is encouraged to try to correct the interference by one or more of the following measures:

- Reorient or relocate the receiving antenna.
- Increase the separation between the equipment and receiver.
- Connect the equipment into an outlet on a circuit different from that to which the receiver is connected.
- Consult the supplier or Contacta for assistance.

This device complies with part 15 of the FCC Rules.  
Operation is subject to the following two conditions: (1) This device may not cause harmful interference, and (2) this device must accept any interference received, including interference that may cause undesired operation.

**IMPORTANT NOTE:** To comply with the FCC RF exposure compliance requirements, no change to the antenna or the device is permitted. Any change to the antenna or the device could result in the device exceeding the RF exposure requirements and void user's authority to operate the device.

### ◆ WEEE Statement

Electrical and electronic equipment must be disposed of at the end of their lifespan separately from household waste.  
Please dispose of this equipment at your local waste collection or recycling center. Please help to protect our environment.



### ◆ Safety and Electromagnetic Emissions Certificates

Standard Compliance

- RoHS compliant

Certificates

- CE
- FCC
- NCC

# Table of Contents

---

■ <b>Product overview</b> .....	1
◆ Front panel	
◆ Rear panel	
■ <b>Display overview</b> .....	2
◆ Standby screen	
◆ Setting screen	
■ <b>Connecting instruction</b> .....	3
■ <b>Operating instruction</b> .....	4
◆ Turn the transmitter on	
◆ Unlock the channel	
◆ Check channel frequency	
◆ Monitor audio via headphone	
◆ Activate mic / aux function	
◆ Turn the transmitter off	
■ <b>Compatible receiver CON-9R</b> .....	4
◆ Interface	
■ <b>Troubleshooting</b> .....	5
■ <b>Specifications</b> .....	6

## Box Contents:

- RF-TXRM (865MHz or 915 MHz)
- 19" Rack Mounting Ear and Fixing Screws
- Earthing Cable
- TNC (Rod) Antenna
- Universal 12v Power Supply (with UK/EU adapter for 865MHz and US/AU adapter for 915MHz)

# Digital Stationary Transmitter

## ■ Product overview

### ◆ Front panel

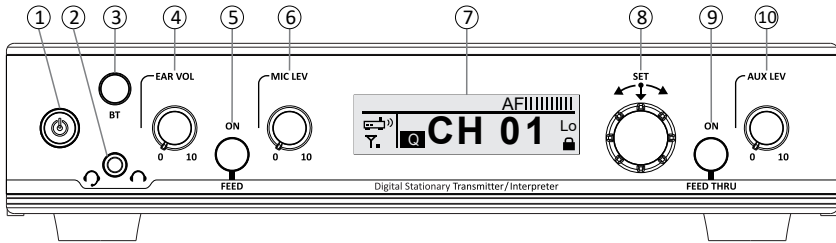

- ① Power button
- ② 3.5 mm headphone / headset-mic socket
- ③ Backlit Bluetooth button
- ④ Headphone volume control
- ⑤ Backlit Mic (Transmitter) / Feed (Interpreter O/I) button
- ⑥ Mic level control
- ⑦ OLED Display
- ⑧ Menu / Set jog dial
- ⑨ Backlit Aux (Transmitter) / Feed Thru (Interpreter O/I) button
- ⑩ Aux-in level (volume) control

### ◆ Rear panel

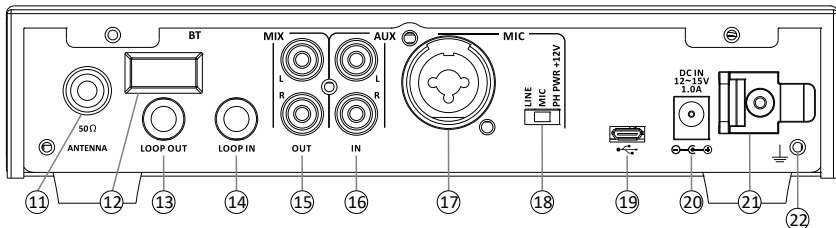

- ⑪ Rod antenna (TNC connector)
- ⑫ Bluetooth sensor
- ⑬ 6.3 mm loop output
- ⑭ 6.3 mm loop input
- ⑮ RCA mix output
- ⑯ RCA aux input
- ⑰ Combo input
- ⑱ Line / Mic / Phantom switch
- ⑲ Uploading port
- ⑳ DC jack
- ㉑ Cable grip
- ㉒ Earthing Screw (Unscrew and attach Earthing Cable if required. Not necessary for all installations)

## ■ Display overview

### ◆ Standby screen

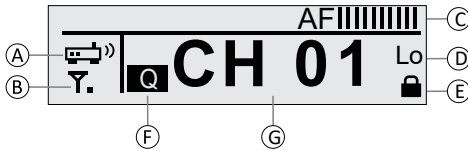

#### (A) Mode

- Transmitter (default)
- Interpreter O (To work with 10-way Language Router LR-10 - \*Mode not activated with RF-TXRM 865/915)
- Interpreter I

#### (B) RF power

- Hi
- Mid
- Low (default)

#### (C) Audio level

- This fluctuates upon audio signals.

#### (D) Aux-in level

- Lo (default): this setting is recommended if the transmitter will be connected with audio source, such as mp3, whose level is lower.
- Hi: this setting is recommended if the transmitter will be connected with professional mixer or other audio source whose level is higher.

#### (E) Channel lock

- Channel will be locked automatically when the transmitter is on.

#### (F) Sound quality

- HQ
- Q (default)

#### (G) Channel number

- Total channel quantity varies upon product and default channel number is 01.

### ◆ Setting screen

- To enter the setting menu, press and keep pressing the jog dial (8) when turning the transmitter on (1).
- Turn the jog dial (8) clockwise to select preferred setting and then press the jog dial (8) again to confirm new selection and return to setting menu.
- To exit the setting menu, select "Save and Exit" and press the jog dial (8) again.

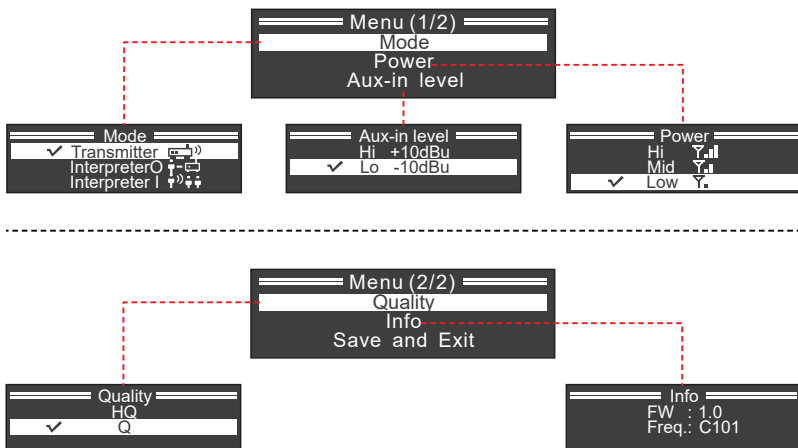

## ■ Connecting instruction

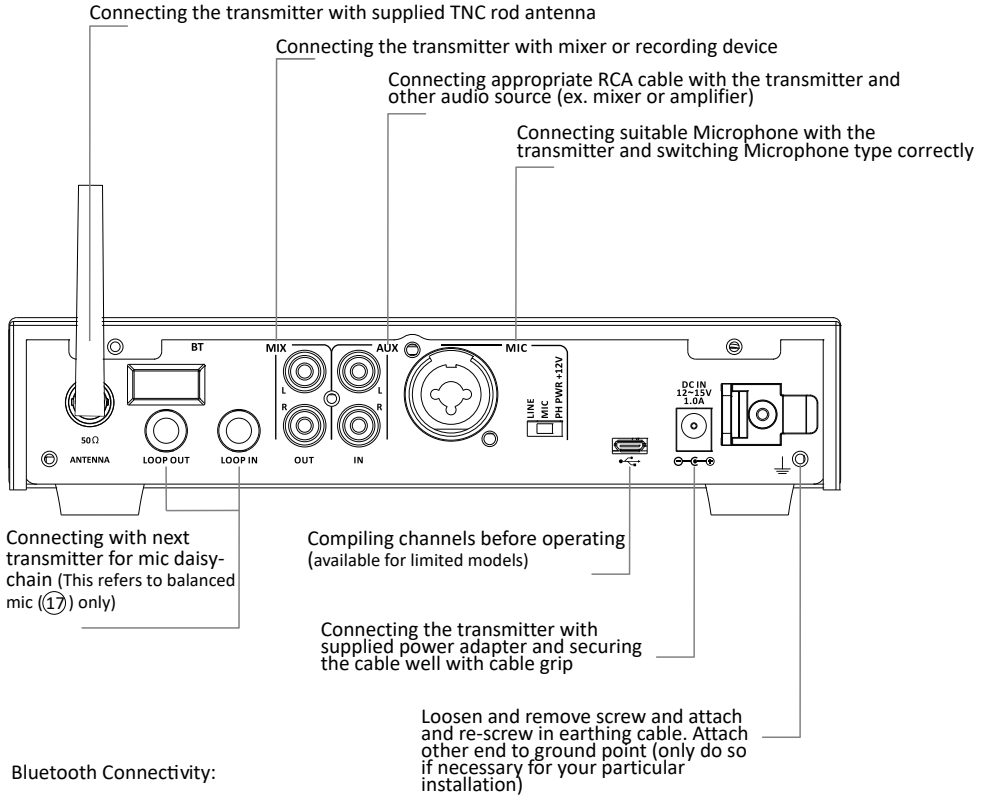

Bluetooth Connectivity:

Refer to ③ Bluetooth Indicator

- Press the Bluetooth button to start pairing.
- Name of DST Bluetooth: DST01~10
- LED status

Activated: Blue light

Not paired: Flashing

Paired: Steady Light

(De-activated: No light)

- Default setting is OFF.

Once paired with your device, wireless audio streaming will be possible to the RF-TXRM. Make sure that your device is always within its Bluetooth Operating Range to maintain connection with the RF-TXRM. Performance and sound quality will vary according to the settings and capabilities of the device used for streaming.

# Digital Stationary Transmitter

## ■ Operating instruction (Mode: Transmitter)

- ◆ Turn the transmitter on  
Press the power button ① for 1 second to turn the transmitter on.
- ◆ Unlock the channel  
Channel will automatically be locked when the transmitter is on. Press and keep pressing the jog dial ⑧ until symbol “” disappears. Then, turn the jog dial clockwise to select preferred channel number which will be locked when the jog dial is pressed again.
- ◆ Check channel frequency  
Short press the jog dial ⑧ when the transmitter is at standby screen to check the frequency of selected channel.

### ◆ Monitor audio via headphone

Connect 3.5mm headphone or headset mic and tune the volume control ④ at appropriate position to monitor audio on the transmitter. Note all audio signals except mic-in ②①⑦ can be monitored.



Listening at high volume for long periods may damage your hearing.

### ◆ Activate mic / aux function

Press the mic / aux button ⑤⑨ to activate or deactivate the function. Tune the mic / aux level via the control ⑥⑩ at appropriate position. Note when headset mic is in use, make sure mic volume ⑥ is appropriately adjusted in addition to aux volume ⑩.

### ◆ Turn the transmitter off

Press the power button ① for 2 seconds to turn the transmitter off

## ■ Compatible receiver RF-RX1-865/915

### ◆ Interface

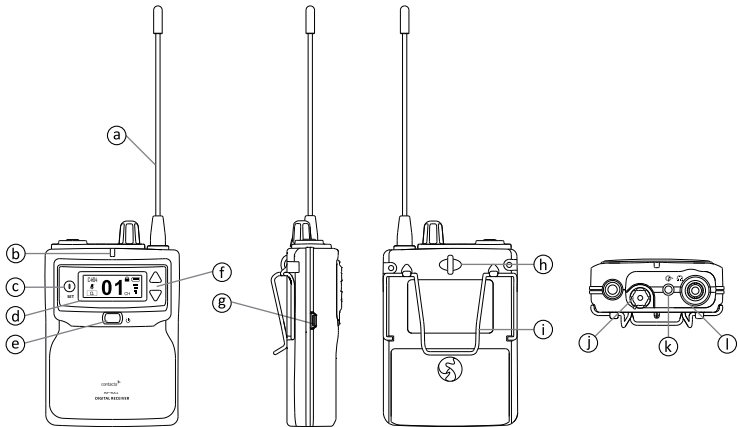

- |                    |                    |   |                  |
|--------------------|--------------------|---|------------------|
| ① Flexible antenna | ④ Backlit screen   | ⑧ Charging port (when NiMH battery applied) | ⑩ Belt clip      |
| ② Rx LED indicator | ⑤ Power button     | ⑨ Lanyard hole                              | ⑪ Volume knob    |
| ③ Set button       | ⑥ Up / Down button | ⑫ Line-out jack                             | ⑬ Headphone jack |

### Screen

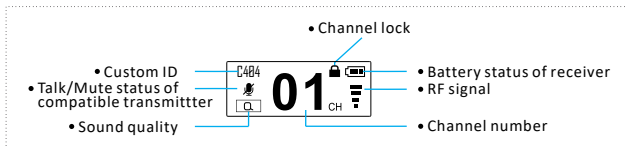

## ■ Troubleshooting

Trouble	Solution
Why can't I turn the transmitter on?	<ul style="list-style-type: none"><li>● Check if the transmitter is connected with power supply.</li></ul>
Why can't I hear anything from bodypack receiver?	<ul style="list-style-type: none"><li>● Check if the bodypack receiver is turned on.</li><li>● Check if selected channel on both transmitter and receiver match..</li><li>● Check if the volume of bodypack receiver is tuned at appropriate level.</li><li>● Check if the bodypack receiver is located within the operation range of the transmitter.</li></ul>
Why can't the transmitter send audio signal?	<ul style="list-style-type: none"><li>● Check if the input signal is well connected with the transmitter.</li><li>● Check if the mic / aux level is tuned at appropriate level.</li></ul>
Why is the operation range shorter?	<ul style="list-style-type: none"><li>● Check if the attached antenna is fixed well.</li><li>● Check if the audio level is pre-set correctly.</li><li>● Adjust the RF power in the setting menu.</li></ul>
Why is the volume of the transmitter quite low?	<ul style="list-style-type: none"><li>● Check if aux-in level is set correctly (Lo / Hi).</li></ul>



## ■ Specifications

Carrier frequency range	865/915 MHz (country dependent)
RF output power	<ul style="list-style-type: none"><li>● Hi: 18 dBm</li><li>● Mid: 13 dBm (country dependant)</li><li>● Lo: 10 dBm</li></ul>
Antenna	TNC connector
Headphone output	200 mW @ 32 ohm
Inputs:	<ul style="list-style-type: none"><li>● Mic in: 3.5 mm &amp; 6.3 mm</li><li>● Aux in: RCA</li><li>● Loop in: 6.3 mm</li></ul>
Mic/Line Inputs:	<ul style="list-style-type: none"><li>● Mic Input Limits: -30dBv</li><li>● Line Input Limits: 10dBv</li><li>● Unbalanced/Balanced Connections available</li></ul>
XLR Connector:	<ul style="list-style-type: none"><li>● Level = \-30dBv</li><li>● Balanced Connection</li></ul>
Mic-In Connectors:	<ul style="list-style-type: none"><li>● Mono/Stereo</li><li>● Aux out = Mono</li><li>● Mic Level = -30dBv</li></ul>
Connectors:	<ul style="list-style-type: none"><li>● AUX IN = Audio Source</li><li>● MIC IN = Dynamic Mics</li><li>● PH PWR = Electret Mics</li></ul>
Outputs:	<ul style="list-style-type: none"><li>● Earmic out: 3.5 mm, stereo</li><li>● Aux out: RCA</li><li>● Loop out: 6.3 mm</li></ul>
Wireless coverage	>100 meters (line of sight @ Hi power)
Power requirements	100 ~ 240 V AC / 12 V DC; 1A switching power
Dimensions(D x W x H)	215 x 210 x 51 (mm)/8.465 x 8.267 x 2.007 (inches)
Weight	1.25 kgs/2.755 lbs

※Specifications are subject to change without prior notice.

Version:9150-018-C2-0124



# contacta

Contacta UK

Contacta Systems Ltd

Office 13, Dana Estate

Transfesa Road

Paddock Wood

TN12 6UT

(Tel) +44 (0) 1732 223900

Contacta Inc (USA)

4025 Tampa Rd,

Suite 1107A,

Oldsmar, FL 34677

(Tel) +1 616 392 3400 (USA & Canada)