

# A500 DECT 6.0

## Amplified Cordless Phone with Answering Machine

### User's Guide



\*Instructions are included for  
*optional* additional handsets.

  
**ClearSounds**™  
*It's Communication Amplified.*



# Welcome

Thank you for purchasing the ClearSounds A500 amplified cordless telephone with answering machine.

If you purchased additional A500E expandable handsets: This guide also applies to your expandable handsets.

We hope that you enjoy the robust feature set of your new phone!

- Handset carrying clip
- Headset-compatible
- Large, backlit keys
- Four languages, with voice prompt while dialing, scrolling lists and receiving incoming calls
- Large, backlit display shows time, number of unheard messages, missed call notification and the number being called
- Alarm clock with snooze function
- Multiple ringtones, personalized ringtones and five selectable ringtone volumes
- Bright strobe-light ringing notification
- Silence ringing with one touch
- Handset volume control, amplification and tone equalizer
- Handset and base speakerphones with volume control
- One-touch calling via four handset memory keys
- Last number redial
- Mute

# Welcome

- Transfer calls and conference calling
- Dialed calls list (last ten calls)
- Personal phonebook (200 entries)
- Answering machine with memo feature and remote access
- Compatible with hearing aid T-coil feature and audio neckloops
- If contracted with your service provider:
  - Voicemail (message waiting indication)
  - Call waiting
  - Caller ID (last 30 calls), talking caller ID
  - Non-viewed calls indication

## Contact information

Please contact us with any questions that you might have.  
We are happy to assist you!

ClearSounds Communications, Inc.

1743 Quincy Avenue, Suite 155

Naperville, IL 60540 USA

800-965-9043 (toll-free)

[www.clearsounds.com](http://www.clearsounds.com)

## Safety precautions

Carefully read and observe the warnings and cautions in this manual and on the equipment.

### Warnings



Warnings must be observed to prevent bodily injury.

**WARNING:** Use the phone only in the described manner to avoid bodily injury or damage to the equipment.

**WARNING:** Locate and use the phone away from water and damp areas, such as swimming pools, bathtubs, sinks and damp basements, and do not use the phone when you are wet, to avoid electrical shock. If the phone is submerged, unplug the base from AC power before you retrieve the phone.

**WARNING:** Do not overload extension cords or power strips. This can result in electric shock.

**WARNING:** Use this phone only with the supplied AC power adapter assembly. Other types of power adapter assemblies can damage the phone and cause personal injury.

**WARNING:** Avoid using the phone during an electrical storm. There is a slight risk of electrical shock from lightning during a storm.

## Safety precautions



**WARNING:** The phone can emit excessive volume and amplification that can cause hearing loss. For each user to adjust the volume to personal preferences, keep the volume adjusted to low level. Do not place your ear next to the ringer.

**WARNING:** Do not spill liquid on the phone or clean the phone while it is plugged in to AC power. This can cause a short circuit, a fire or electric shock.

**WARNING:** Do not push any type of object into the telephone. Contact with dangerous voltage points can occur, resulting in fire, electric shock or parts damage.

**WARNING:** Do not disassemble the phone. Dangerous voltages or other risks can occur. Use after incorrect reassembly can lead to electric shock.

**WARNING:** If you are in the vicinity of a gas leak, do not use the phone. The phone can produce a spark that can lead to fire or explosion.

## Cautions



Cautions indicate practices that could harm the phone or other objects.

**CAUTION:** Do not place objects on the cables or cords, and place them away from foot traffic.

**CAUTION:** Locate the phone away from heat sources of any type. Keep slots and openings on the components uncovered to enable ventilation and protection against overheating.

**CAUTION:** Connect the supplied AC power adapter assembly into a surge protector. Power surges can damage the phone.

**CAUTION:** Use only a damp cloth to clean the unit. Do not use liquid or aerosol cleaners.

**CAUTION:** In these circumstances, unplug the phone from AC power, and refer to qualified service personnel:

- Liquid spills in the phone, or it is exposed to rain or precipitation.
- The phone does not operate according to descriptions in this manual, or performance of the phone distinctly changes.
- The phone is dropped or the casing is damaged.

# Contents

Setup .....	10
Unpack .....	10
Install handset batteries.....	11
Connect the cords .....	13
Charge the batteries .....	14
Carrying clip (optional).....	15
Important concepts .....	16
Personalize your phone.....	16
Choose answering machine or voicemail .....	16
Let's begin! .....	17
Register additional handsets .....	17
Place a call .....	17
Answer a call .....	17
Handset .....	18
Backlighting .....	19
Home screen .....	19
Icons .....	19
Let's navigate .....	21
Handset keys.....	23
Area settings.....	26
Language.....	26
Call storage: local area code .....	28
Dialing mode.....	29
Display adjustments .....	30
Handset name .....	30
Screen contrast .....	31
Backlight-on time .....	31
Date and time .....	32



Audio adjustments .....	34
Consistently amplified volume .....	34
Tone equalizer .....	35
Keypad beep .....	36
Confirmation beep .....	36
Handset voice prompt.....	37
Paging and alarms.....	40
Page a lost handset.....	40
Alarm .....	40
Assistive listening .....	43
T-Coil .....	43
Neckloops.....	43
Call notification adjustment.....	44
Ringtones .....	44
Ringer volume .....	46
Memory keys .....	48
Manually store or edit a memory-key entry .....	48
Delete a memory-key entry .....	52
Keypad tips.....	53
Using the keypad .....	53
Inserting a pause.....	54
What is a pause?.....	54
For example.....	54
Insert pauses while storing a number.....	55
Phonebook .....	56
Manually store phonebook entries.....	56
Store entries from lists.....	58
Copy entries from one handset to another .....	60

# Contents

Edit a phonebook entry.....	63
Delete one or all phonebook entries.....	65
Memos.....	66
Record a memo .....	66
Retrieve a memo .....	67
Answering and calling.....	71
Auto answering .....	71
Answer, place or end a call.....	73
Silence a ringing handset .....	74
Place a one-touch call .....	74
Redial a number .....	75
Call from your phonebook .....	76
Call from the inbound calls list.....	77
Call other handsets in your home (intercom)....	78
During calls.....	79
Adjust sound.....	79
Use the speakerphone .....	80
Mute the microphone.....	81
Transfer a call.....	81
Use a headset .....	82
Set up a conference call .....	83
Answering machine adjustments.....	84
Is the answering machine right for you?.....	84
Answering machine with call waiting .....	84
Turn on or off the answering machine .....	85
Record a personalized greeting.....	87
Listen to your greeting .....	89
Restore the default greeting .....	90

Personalize your remote access security code .	90
Change the number of rings before pickup .....	93
Voicemail and inbox.....	96
Screen a call.....	96
Intercept a call waiting call.....	96
Visual indicators of calls and voicemail .....	97
Review inbound calls.....	98
Listen to voicemail messages.....	98
Machine messages.....	99
Screen a call.....	99
Intercept a call during an incoming message ....	99
Visual indicators of messages .....	100
Listen to answering machine messages.....	100
Delete machine messages and memos .....	106
List maintenance .....	108
Delete entries from lists .....	108
Security.....	109
Personalize the system PIN .....	109
Restoring defaults.....	111
Restore handset default settings .....	111
Additional handsets .....	113
Register additional handsets to the base .....	113
Delete a handset registration.....	114
Troubleshooting.....	115
Compliance.....	122
Warranty .....	128
Accessories .....	130
Service.....	131

# Setup

## Unpack

Ensure that your packing box includes all of these parts. If any parts are missing or damaged, please contact your vendor or ClearSounds.

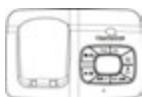

Answering machine base



Handset

(Optional) additional A500 handsets are available. Each additional handset comes with an A500 base, a power adapter, batteries, a carrying clip and a Setup Guide.



Phone line cord



AC power adapter assembly



Three rechargeable AAA NiMH batteries



Carrying clip



User's Guide

**IMPORTANT: YOUR RECEIPT IS REQUIRED FOR WARRANTY. PLEASE RETAIN YOUR RECEIPT.**

## Install handset batteries

Follow these warnings to avoid explosive or caustic reactions.



**WARNING:** Insert batteries according to the marked polarity symbols.

**WARNING:** Use only rechargeable AAA NiMH batteries. Other types of batteries can damage the phone and cause personal injury. Do not mix battery brands, battery types (chemistries) or exhausted/full batteries.

**WARNING:** Do not attempt to recharge a battery unless it is marked “rechargeable.”

**WARNING:** Immediately remove exhausted batteries, and dispose of them properly.

**WARNING:** Do not burn exhausted batteries.

**WARNING:** Do not dispose of batteries with household waste. Recycle or dispose of batteries according to regulations of your local municipality.

## Setup

To install handset batteries

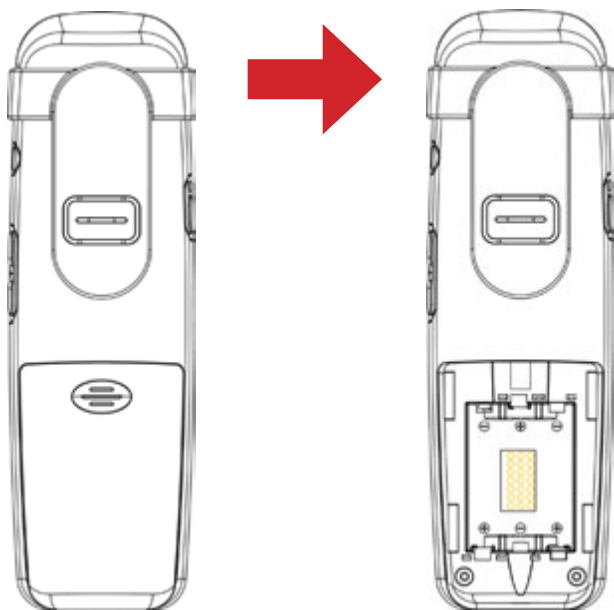

1. Slide back the battery cover and remove the cover.
2. Insert the batteries according to the marked polarity symbols.  
The flat side of each battery presses against a spring.
3. Slide the battery cover until it snaps into place.

## Connect the cords

To avoid potential interference, place the phone away from electronic equipment.

On the underside of the base, thread the cord(s) between the guides.

### To connect the cords

To AC outlet

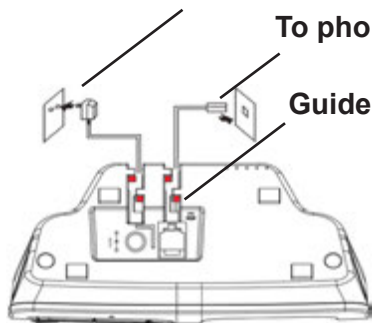

**A 500 base**

To phone jack

To AC outlet

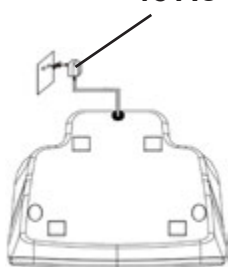

**(Optional) A500E charger**

### If you subscribe to DSL service

If you hear noise during conversations or if the caller ID function does not work properly, please obtain and attach a DSL noise filter.



Attach the filter between the telephone cord and the telephone communication jack in the wall.

# Setup

## Charge the batteries

Before you use the phone for the first time, fully charge the batteries for approximately 24 hours.

Recharge the batteries regularly.

**Note:** If  or  appears on the screen, the battery charge is low or depleted. If you attempt to fully recharge the batteries and the battery icon does not return to , insert fresh batteries.

## To charge the batteries

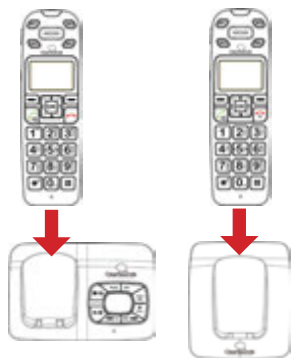

1. Place the telephone handset on the base.

A beep occurs and  flashes as the phone charges.



## Carrying clip (optional)

If you want to converse using a headset while keeping your hands free, you can attach the handset to a belt and use a handset or base speakerphone.

### To install the carrying clip

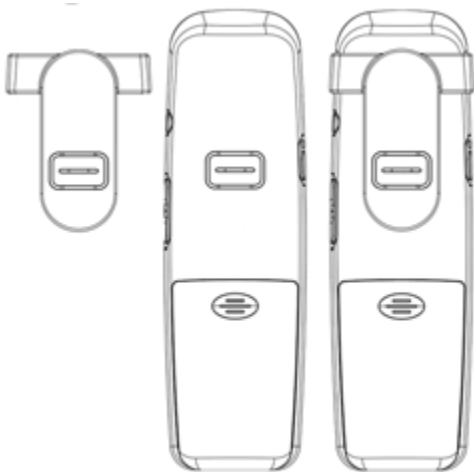

1. On the back of the phone, align the arms of the carrying clip above the slots on the sides of the phone.
2. Gently press the arm clips into the slots.

## Important concepts

### Personalize your phone

The ClearSounds A500 phone is feature-rich.

This manual describes all available features. Scan the topics, and if you see an interesting feature, follow the instructions to personalize your phone.

### Choose answering machine or voicemail

Before you set up and personalize your new phone, decide how you prefer to store messages. You must choose one method as a primary message retrieval method: answering machine or voicemail.

The phone includes a built-in answering machine. Voicemail service is purchased through your telephone service provider. Each method has unique features and benefits.

When your line is engaged, voicemail service detects and stores a record of incoming calls and messages, whereas the answering machine does not.

If you prefer using an answering machine for easy message access, but you also want to be alerted to incoming calls when you are on the line with another caller, you can primarily use the answering machine and purchase voicemail with the caller ID on call waiting feature. For further information, see [page 84](#).

By default, the answering machine is turned off. To turn on the answering machine and set it up, see [page 85](#).

# Let's begin!

## Register additional handsets

Your telephone handset is registered to the base (Base 1).

If you purchased additional ClearSounds A500E handsets, you must register each additional handset to the base. For registration instructions, see [page 113](#).

## Place a call

**Note:** You can reverse Step 1 and Step 2, but you can make corrections only if you dial in Step 1.

1. Press the alphanumeric keys.

If you make a mistake, press  beneath **Clear** on the screen.

2. Press  and speak.

Call duration appears on the handset screen.

3. To end the call, press .

## Answer a call

1. Lift the handset from the base.

2. Press  and speak.

Call duration appears on the handset screen.

3. To end the call, press .

# Handset

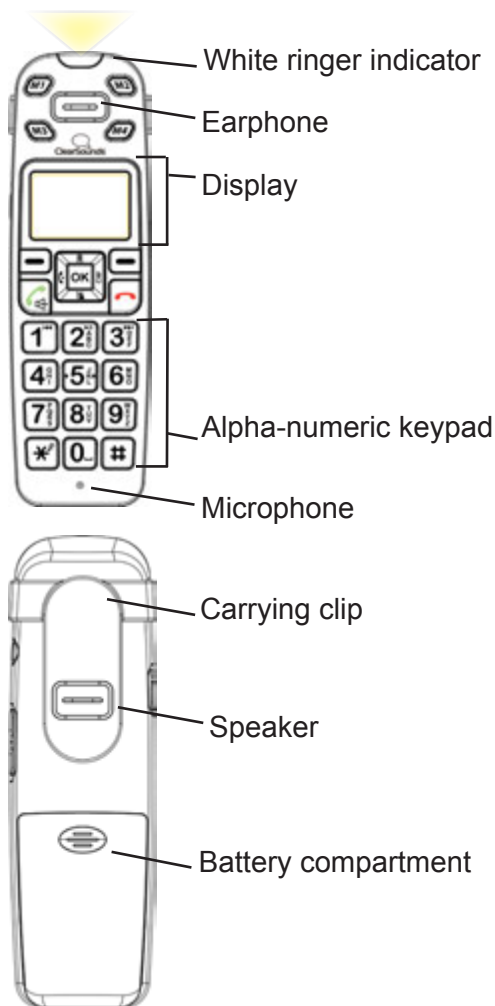

## Backlighting

The display and keys light when you lift the handset from the base or when you press handset keys.

After 20 seconds, the backlighting turns off. To turn it on again, press .

## Home screen

The home screen is the phone display that you see when the phone is at rest or when you press .

## Icons



Display icons appear here.



Signal strength

Blinks if the handset is out of range of the base.



Battery strength

Black = fully charged  
White = depleted.

# Handset



Incoming call  
(toggles)

An incoming call is occurring.



Line in Use

The phone line is engaged.



Speakerphone on

The handsfree speakerphone is on.



Amplification is on

Phone amplification is on. To turn it off, press  on the handset side.



Missed calls  
(flashes)

There are one or more unreviewed missed calls.



Messages  
(Voicemail service)

One or more unprocessed voicemail messages.



Answering machine on

The answering machine is turned on.



Answering machine off

The answering machine is turned off.



Intercom

The internal communication phone line is engaged.



Alarm clock set

The alarm is set to ring.



Ringer off

The handset and base ringer are set to off.

## Let's navigate



Take these steps to practice basic navigation through the menus.



All instructions in this manual begin from the home screen.

To begin steps from the home screen, press 



Select keys

When you press   beneath a command on the screen, you select or implement the command.

For example, if you press  beneath **Back**, you return to the previous screen. If you press  beneath **Select**, you select the highlighted menu item.

1. Press  beneath **Menu**.



The main menu appears on the screen.



## Handset



Scroll pad-  
OK key

When a menu list is present on the screen, you can scroll through the list by pressing the top and bottom pads on the scroll pad.

2. Press  and scroll down the list. Now press  and scroll up the list.

You can also select a highlighted menu item by pressing . This is the same as pressing  beneath **Select**.

Because  is convenient, throughout the manual we instruct you to press it to select highlighted menu items.

3. Press .

No matter where you are in the menus, you can always press this key to return to the home screen.

4. Press .

The Home screen appears.



Home key



## Handset keys

Most keys have several functions. Take a few minutes to explore all of the keys.

This is a good time to become familiar with the keys. Later, you can refer to these diagrams, as necessary.

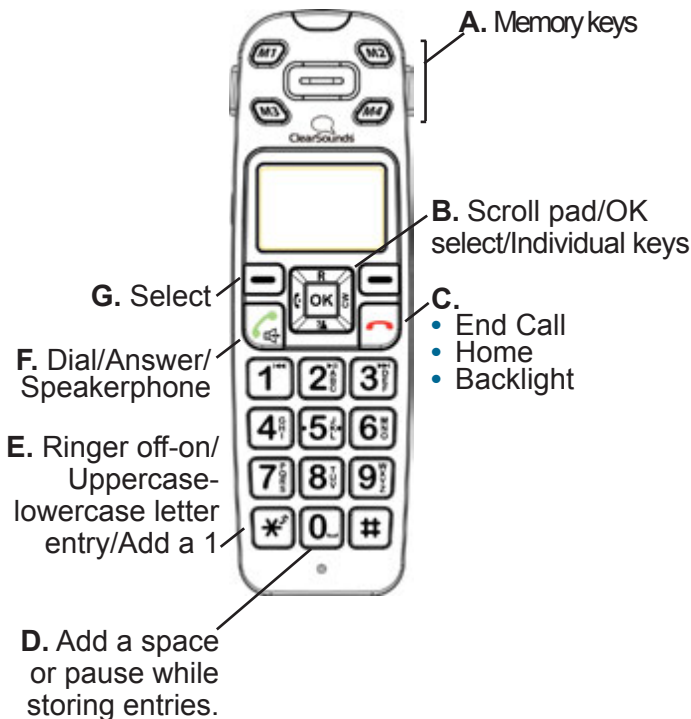

# Handset



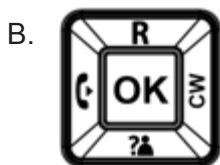

**Memory keys** For one-touch calling, you can store one commonly called number in each of the four memory keys.



## Scroll pad

- **If the screen shows a menu**

**list:**  scrolls up the list  
and  scrolls down the list.

- **If no menu list is present on the screen:**

 Enters the inbound calls list.

 Enters the dialed calls list.

 Toggles between callers (call waiting service required).

 Places an internal call to another handset that is registered to your ClearSounds A500 base.



**Selects** a highlighted menu item or the text that appears above



on the left side of the screen.

C.



**End call key** Ends a call.

**Home key** No matter where you are in the menu structure, returns you to the home screen.

**Backlighting key** From the home screen, turns on the backlighting.

D.



**Inserts a space:** While storing letters.

**Inserts a pause:** While storing numbers: (For further information, see ["What is a pause?" on page 54](#)).

E.



**Ringer:** Turns it on or off

**Uppercase/lowercase letters:** While storing letters, switches between case.

**Adds a 1:** While dialing from a stored number.

F.



**Dial/Answer** Places a call or answers a call.

**Speakerphone** During a call, activates the speakerphone for handsfree conversation.

G.



**Select keys** Implement the command that appears directly above on the screen. The commands change as you scroll through menus.







## Area settings

### Language

The default display and prompt language on the handset and the answering machine is English.

You can select from English, French, Spanish and Chinese.

#### To change the handset language

1. Press  beneath **Menu** on the screen.
2. Press  and scroll to the fourth item in the list, and then press .
3. Press  to select the first item in the list.
4. Press  and scroll to the language of your choice, and then press .

A confirmation tone occurs and **Saved** appears on the screen.

5. Press .

#### To change the answering machine language, using the base













1. On the base, press and hold  for 10 seconds.

The base emits a tone and a language option appears on the base screen. The displayed language is selected.

- (Optional) To change to another language, repeat Step 1 until the language of your choice appears on the screen.

## To change the answering machine language, using the handset



- Press  beneath **Menu** on the screen.
- Press  to select **Ans Machine**.
- Press  and scroll to **Ans Settings**, and then press .
- Press  and scroll to **Language**, and then press .  
The current setting is highlighted on the screen.
- Press  or  and scroll to your choice, and then press .  
Saved appears on the screen.
- Press .

## Area settings

### Call storage: local area code







If you subscribe to caller ID service, you can quickly place a call, without dialing, by selecting a call in the incoming calls list and pressing .

The A500 phone stores all incoming calls with their area codes. If an area code is not required for local dialing in your region, you might prefer that the A500 store local incoming calls *without* the area code, so that you can call out from the incoming call list.

If you take these steps to specify your area code, the phone stores local calls without the area code, and it continues to store long-distance calls with their area codes.

**Note:** To undo this function, take all of the same steps, but *delete* the area code in Step 4.

### To specify local call storage without the area code









1. Press  beneath **Menu** on the screen.
2. Press  and scroll to **Setting**, and then press .
3. Press  and scroll to **Area Code**, and then press .
4. Press numeric keys to enter your area code, and then press .
5. Press .

## Dialing mode

When you place a call, the phone generates numbers by tone or by pulse. By default, your phone is set to the tone dialing mode.

Should you need to change this setting based on your telephone service, use **Tone** for touch-tone service, or use **Pulse** for rotary dialing.

### To set the dialing mode









1. Press  beneath **Menu** on the screen.
  2. Press  and scroll to **Setting**, and then press .
  3. Press  and scroll to **Dial Mode**, and then press .
  4. Press  and scroll to your choice, and then press .
- A confirmation tone occurs and **Saved** appears on the screen.
5. Press .

# Display adjustments

## Handset name

By default, the handset is named HS1. You can re-name the handset, and the name displays on the screen.

### To rename the handset







1. Press  beneath **Menu** on the screen.
2. Press  and scroll to **Display**, and then press .
3. Press  and scroll to **Handset Name**, and then press .
4. Remove the current name by repeatedly pressing  beneath **Clear** on the screen.
5. Enter the new name by pressing alphanumeric keys, and then press .  
To scroll through multiple letters on a key: Press rapidly.  
To enter a space: Press .  
To enter the same letter twice: Pause between pressing.  
A confirmation tone occurs and **S a v e d** appears on the screen.
6. Press .



## Screen contrast

You can adjust the contrast of the handset screen to optimize visibility in different environmental conditions. Five contrast levels are available.

### To adjust the screen contrast

1. Press  beneath **Menu** on the screen.
2. Press  and scroll to **Display**, and then press .
3. Press  to select **Contrast**.
4. Press  and scroll to your choice, and then press .

A confirmation tone occurs and **Saved** appears on the screen.

5. Press .







## Backlight-on time

When you lift the handset from the base or when you press handset keys, the display and keys light.

By default, the backlighting turns off after 20 seconds. You can set the backlight time to 10, 20, 30 or 40 seconds.

## Display adjustments

### To adjust the backlight-on time

1. Press  beneath **Menu** on the screen.
2. Press  and scroll to **Display**, and then press .
3. Press  and scroll to **Backlight Time**, and then press .
4. Press  and scroll to your choice, and then press .

A confirmation tone occurs and **Saved** appears on the screen.

5. Press .

### Date and time

You can manually set the handset date and time and the time format.





However, if you subscribe to caller ID service, your phone automatically sets the date and time when the first call arrives after phone setup or after a time change.

If you unplug the base, you must reset the time and date.

### To set the date and time display

If you do not subscribe to caller ID service, you must set the date and time.

1. Press  beneath **Menu** on the screen.







2. Press  and scroll to **Setting**, and then press .
3. Press  and scroll to **Date and time**, and then press .
4. Enter the last two digits of the year by pressing alphanumeric keys, and then press .
5. Repeat Step 4 for Month, Day, Hour (you must use 24-hour format) and Minute.

A confirmation tone occurs and **Saved** appears on the screen.

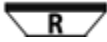
6. Press .

## To set the time format

You can select the 12-hour format or the 24-hour format.

1. Press  beneath **Menu** on the screen.
2. Press  and scroll to **Setting**, and then press .
3. Press  and scroll to **Time format**, and then press .
4. Press  and scroll to your choice, and then press .

A confirmation tone occurs and **Saved** appears on the screen.

5. Press .

## Audio adjustments

### Consistently amplified volume

By default, when you end a call during which you amplified the volume, the amplification turns off for the next call.







If you prefer amplified volume consistently, you can set it to automatically turn on each time that a call begins.

During conversation, you can still temporarily turn off the amplification.



**WARNING:** Consider the hearing levels of other phone users before you set amplification consistently ON. The phone can emit excessive volume and amplification that can cause hearing loss.

### To turn on or off consistently amplified volume

1. Press  beneath **Menu** on the screen.
2. Press  and scroll to **Sound**, and then press .
3. Press  and scroll to **Boost**, and then press .
4. Press  and scroll to your choice, and then press .

A confirmation tone occurs and **Saved** appears on the screen.

5. Press .





If you turned on amplification, **BOOST IS ON** remains on the screen.

## Tone equalizer



You can set the handset earpiece to equalize treble, flat or base tones.

You can also adjust this setting during a call, which enables you to hear the results as you adjust. For instructions to adjust during a call, see [page 79](#).

### To adjust the tone equalizer

1. Press  beneath **Menu** on the screen.
2. Press  and scroll to **Sound**, and then press .
3. Press  and scroll to **Equalizer**, and then press .

A graph appears on the screen.

4. Press  and scroll to your choice, and then press .

A confirmation tone occurs and **Saved** appears on the screen.







5. Press .

## Audio adjustments

### Keypad beep

When you press a key, a tone sounds. If you prefer silent key presses, you can turn off keypad beep.

#### To turn off or on keypad beep

1. Press  beneath **Menu** on the screen.
2. Press  and scroll to **Sound**, and then press .
3. Press  and scroll to **Keypad Beep**, and then press .
4. Press  and scroll to your choice, and then press .  
A confirmation tone occurs and **Saved** appears on the screen.









5. Press .

### Confirmation beep

When you save a menu selection, a confirmation tone occurs and **Saved** appears on the screen.

You can turn off or turn on the confirmation beep.

## To turn off or turn on the confirmation beep

1. Press  beneath **Menu** on the screen.
  2. Press  and scroll to **Sound**, and then press .
  3. Press  and scroll to **Confirm Beep**, and then press .
  4. Press  and scroll to your choice, and then press .
- A confirmation tone occurs and **Saved** appears on the screen.
5. Press .

## Handset voice prompt

If you turn on the voice prompt feature, the handset "speaks" numbers under these circumstances:

- While dialing, as you press the alphanumeric keys
- While scrolling your Phonebook list or Memory key entries.







If you subscribe to caller ID service, the handset "announces" callers during incoming calls, in these ways:

- If the caller makes the number available, the handset announces the caller's number.

## Audio adjustments

- If you entered the caller's number in your phonebook or a memory key, and you recorded an identifier for the caller, the handset also plays the identifier. For identifier recording instructions, see "[To manually store a phonebook entry](#)" on page 56 or "[To manually store a memory-key number](#)" on page 48.

### To turn on or off voice prompt







1. Press  beneath **Menu** on the screen.
2. Press  and scroll to **Setting**, and then press .
3. Press  and scroll to **Voice Prompt**, and then press .
4. Press  and scroll to your choice, and then press .

A confirmation tone occurs and **Saved** appears on the screen.

5. Press .

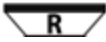

## To adjust the handset voice prompt volume

1. Press  beneath **Menu** on the screen.
2. Press  and scroll to **Sound**, and then press .
3. Press  and scroll to **Voice volume**, and then press .
4. Press  and scroll to your choice, and then press .

A confirmation tone occurs and **Saved** appears on the screen.

5. Press .

# Paging and alarms

## Page a lost handset

You can page lost handsets that are registered to the ClearSounds A500 base.

### To page a handset



- Press and hold  for less than five seconds.

All handsets registered to the base beep for about one minute.

### To stop paging



- Briefly press any key on any beeping handset.







## Alarm

You can use the handset as an alarm. The alarm also has a snooze function.



You can set the alarm to ring once, every day at the same, time or Monday through Friday at the same time.

The alarm rings only at the handset that you set (not at the base or at other handsets that are registered to the base).

## To set the handset alarm

1. Press  beneath **Menu** on the screen.
2. Press  and scroll to **Organizer**, and then press .
3. Press  to select to **Set Alarm**.
4. Press  and scroll to the frequency of your choice, and then press .

If you selected Off, proceed to Step 7.

5. Press numeric keys to enter the alarm time in the 24-hour format (HH:MM), including an initial zero when appropriate, and then press .
6. Press  and scroll to the tone of your choice, and then press .

A confirmation tone occurs, and **Saved** appears on the screen.



7. Press .

If you turned on the alarm,  appears on the screen.

## Paging and alarms

### To turn off a ringing handset alarm

1. Stop the alarm by taking one of these steps:

- To turn off the alarm entirely for this session: Press  beneath **Stop** on the screen.
- To turn off the alarm for five minutes: Press  beneath **Snooze** on the screen.

You can press Snooze five times. After the fifth time, the alarm turns off permanently for the session.

## Assistive listening

The ClearSounds A500 DECT 6 phone is compatible with these assistive listening devices:

- Hearing aids that are equipped with telecoil (T-coil)
- Audio neckloops with built-in microphones and 2.5 mm connectors

### T-Coil

Some hearing aids are equipped with telecoil (T-coil).

#### To use the phone with T-coil-equipped hearing aids

1. Move your hearing aid T-switch to the T position.
2. Hold the handset close to your hearing aid.

### Neckloops

Neckloops amplify phone sound in T-coil-equipped hearing aids.



You can speak handsfree through neckloops that include built-in microphones.

#### To use a neckloop

1. Before or during a call, connect the neckloop to the  jack on the side of the handset.
2. Position the neckloop around your neck.
3. Accomplish these tasks as usual:
  - Answer or place calls
  - Adjust and amplify volume
  - Equalize tone
  - End calls

## Call notification adjustment

Your phone can notify you of incoming calls in several ways.

- Ringer (selectable)
- Handset light and toggling  icon







- Caller ID displays (if you subscribe)



### Ringtones

Three tones are available for the handset and nine are available for the base. The tones don't match, but if the handset is on the base, the base does not ring.



You can also choose a unique handset tone for internal calls from other handsets that are registered to the ClearSounds A500 base.

### To select a ringtone for the handset

1. Press  beneath **Menu** on the screen.
2. Press  and scroll to **Sound**, and then press .
3. Press  to select **HS Ringtone**.

4. Press  and scroll to one of these listings, and then press .









- **External:** To set the ringtone for external calls
- **Internal:** To set the ringtone for internal calls from other handsets registered to the base.

5. Press  and scroll to your choice, and then press .

A confirmation tone occurs and **Saved** appears on the screen.

6. Press .

## To select a ringtone for the base

1. Press  beneath **Menu** on the screen.
  2. Press  and scroll to **Sound**, and then press .
  3. Press  and scroll to **Bs Ringtone**, and then press .
  4. Press  and scroll to your choice, and then press .
- A confirmation tone occurs.
5. Press .

# Call notification adjustment

## Ringer volume









You can adjust the ringer volume for the handset and the phone base, separately. There are five volume levels.

When the handset is in the base, only the handset ringer rings.

### To turn off or on the handset and base ringer







1. Press and hold .  
A confirmation tone occurs.  appears on the screen when the ringer is off.

### To adjust the handset ringer volume

1. Press  beneath **Menu** on the screen.
  2. Press  and scroll to **Sound**, and then press .
  3. Press  and scroll to **Hs Ringer Volume**, and then press .
  4. Press  and scroll to your choice, and then press .
- A confirmation tone occurs and **Saved** appears on the screen.
5. Press .

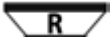

## To adjust the base ringer volume

1. Press  beneath **Menu** on the screen.
  2. Press  and scroll to **Sound**, and then press .
  3. Press  and scroll to **Bs Ringer Volume**, and then press .
  4. Press  and scroll to your choice, and then press .
- A confirmation tone occurs.
5. Press .

# Memory keys

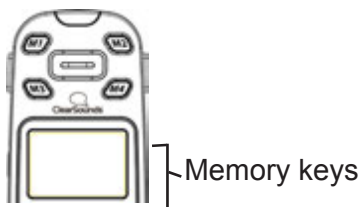

You can store important numbers and associate them with memory keys.

When you press and hold a memory key, the phone calls the number.

You can store memory-key entries in these ways:

- Manually, by using the keyboard to type the entries
- Quickly, by using numbers that are that are stored in the inbound calls list and the dialed calls lists. For quick-method instructions, see ["To store a phonebook or memory key entry, from lists"](#) on page 58.

## Manually store or edit a memory-key entry

**Tip:** To easily access your voicemail messages, you can store your voicemail access number in a memory key by inserting pauses. For further information, see [page 54](#).

### To manually store a memory-key number

1. Press one of the  —  keys.  
Empty appears on the screen.

2. Press  to select **Option**.

48. Press  to select **Edit Entry**.

4. Press alphanumeric keys to enter the name that you wish to store, and then press .

To scroll through multiple letters on a key: Press rapidly.

To enter a space: Press .





To enter the same letter twice: Pause between pressing

5. Press all alphanumeric keys that are required to place the call (1 and area code when required), and then press .

Default Ringtone, Record or Scroll appears on the screen.

6. Save now or specify unique notification by taking one of these steps:

- **To save the information now** and assign a default ringtone: Press .

- **To record or personal identifier** to indicate calls from this person (Caller ID service required): Press  and scroll to **Record or scroll**, and then press . Press  to select **Start**, record an identifier, and then press .

Your recording plays, and Ring Tone Save? appears on the screen. Press  to save the recording.







- **To select a ringtone** to help indicate calls from this person (Caller ID service required): Press  and scroll to the tone of your choice, and then press



.

7. Press .

## Memory keys

### To manually edit a memory-key number

1. Press the  —  key that you wish to edit.  
The currently stored information appears on the screen.
2. Press  to select **Option**.
3. Press  to select **Edit Entry**.
4. Keep or edit the name by taking one of these steps:
  - To keep the current name exactly the same, press .
  - To edit the name, press  beneath **Clear** on the screen, and then press alphanumeric keys to enter the name that you wish to store, and then press .





**Note:** You can press and hold to clear all letters at once.
5. Keep or edit the number by taking one of these steps:
  - To keep the current number exactly the same, press .
  - To edit the number, press  beneath **Clear** on the screen, press all alphanumeric keys that are required to place the call (1 and area code when required), and then press .

**Note:** You can press and hold to clear all numbers at once.



Default Ringtone, Record or Scroll appears on the screen, and the current ringtone or personal identifier plays.

6. Save now or specify unique notification by taking one of these steps:

- **To save the information now** and assign a default ringtone: Press .

- **To record or re-record a personal identifier** to indicate calls from this person (Caller ID service required): Press  and scroll to **Record or scroll**, and then press . Press  to select **Start**, record an identifier, and then press .

Your recording plays, and Ring Tone Save? appears on the screen. Press  to save the recording.

- **To select a ringtone** to help indicate calls from this person (Caller ID service required): Press  and scroll to the tone of your choice, and then press .



7. Press .

## Memory keys

### Delete a memory-key entry

1. Press the  key that you wish to delete.  
The currently stored information appears on the screen.

2. Press  to select **Option**.

3. Press  and scroll to **Delete Entry**, and then press .

Delete Entry? appears on the screen



4. Press .



5. Press .

## Keypad tips



### Using the keypad

- **Letter or number:** When you press an alphanumeric key on a keypad, the number is selected (for tasks where numbers are appropriate) or a letter is selected (for tasks where letters are appropriate).
- **Which letter?:** Each key has more than one letter available, and you find a letter by repeatedly pressing the key until you see it.
- **Case:** To change the case of a letter, press  before you press the letter.
- **Enter the next character:** Press the next key. If the next character resides on the same key, wait until the cursor moves to the next position before you press the key again.
- **Enter spaces:** Press .
- **Corrections:** To erase the last character that you entered, press  beneath **Clear**. Hold it for two seconds to delete all characters.
- **Special characters:** Press these numeric keys repeatedly until you see these special characters:

Key	Special characters
	. , ' ? ! " - ( ) @ / : ; =
	+ & _ \$ £ € ¥ < > # *

## Inserting a pause

### What is a pause?

Do you frequently call an automated service number that includes interactive voice prompts? A service that requests passwords or steps you through menu choices, like your bank or your voicemail?



If so, you can save time by storing the service number and all of the required responses into a memory key. It takes a little patience to set up, but once it is stored, whenever you press the memory key, the phone does all of the work for you!

Automated service messages always include a few seconds before each prompt begins. So when you program the memory key, you must insert one or more pauses to wait for each prompt to begin. After pauses, you enter the additional numbers that the prompt requires.

In the ClearSounds A500 phone, a pause is three seconds long. To insert a pause while storing a number, you press and hold .

### For example

To store your voicemail number in a memory key, you would store a series of numbers, as follows:

- Your voicemail access number
- Two pauses ( ) to wait for your recorded voicemail message to begin
-  to enter the voicemail menu



- One pause (**0**) to wait for the passcode prompt
- Your passcode and **#**.

## Insert pauses while storing a number

A pause is 3 seconds long. While storing an automated service number and all of its required responses into a memory key, you must enter pauses before each automated prompt.

### To store an automated service number and responses

1. Jot down the automated service number.
2. Call the number, and jot down the following, until you reach the destination:
  - a. The number of seconds between the last number dialed and the first prompt
  - b. The next required response
3. Using your notes, follow the instructions for storing a memory-key number (for instructions, see [page 48](#)).

While storing the number and required responses, press and hold **0** one or more times in sequence, to equal the number of seconds before each prompt.

P appears on the screen for each pause.

# Phonebook

You can build a personal phonebook so that you can easily make calls with a few key presses. You must store phonebook entries separately for each handset, but you can copy entries from one handset to another. Each handset can hold 200 phonebook entries.





You can store phonebook entries in these ways:

- Manually, by using the keyboard to type the entries.
- Re-using numbers that are that are stored in the inbound calls list and the dialed calls list
- Copying one or all entries from one handset to another

## Manually store phonebook entries

**Note:** Enter long distance codes and area codes that are required for dialing, so that you can simply select the phonebook entry and pick up the handset to call. You can enter up to 24 digits and pauses.

### To manually store a phonebook entry

1. Press  beneath **Phnbk** on the screen.
2. Press  to select **Option**.
3. Press  to select **New Entry**.
4. Press alphanumeric keys to enter the name that you wish to store, and then press .

To scroll through multiple letters on a key: Press rapidly.

To enter a space: Press .





To enter the same letter twice: Pause between pressing.

5. Press all alphanumeric keys that are required to make the call (area code and 1 when required), and then press .



Default Ringtone, Record or Scroll appears on the screen.

6. Save now or specify unique notification by taking one of these steps:

- **To save the information now** and assign a default ringtone: Press .

- **To record a personal identifier** to indicate calls from this person (Caller ID service required): Press  and scroll to **Record or scroll**, and then press . Press  to select **Start**, record an identifier, and then press .

Your recording plays, and Ring Tone Save? appears on the screen. Press  to save the recording.

- **To select a ringtone** to help indicate calls from this person (Caller ID service required): Press  and scroll to the tone of your choice, and then press .

7. Press .

# Phonebook

## Store entries from lists



You can quickly add a number to your phonebook or memory key, from these lists:

- The dialed calls list
- If you subscribe to caller ID service, the inbound calls list

**Note:** As you store entries, be sure to add long-distance codes as necessary, so that your phone can dial the numbers directly. If area codes are not required for local calls in your region, see [page 28](#) for instructions on specifying that the phone not save the area code in lists.

## To store a phonebook or memory key entry, from lists

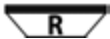
1. Search a list by taking one of these steps:



- To store a number from the dialed calls list: press  repeatedly until you see the call that you want to store.
- To store a number from the inbound calls list: Press  repeatedly until you see the call that you want to store.

2. Press  to select **Option**.



3. Specify save location by taking one of these steps:

**Note:** If you save to a memory key with a stored entry, the new entry replaces the entry.

- To save to the phonebook, press  to select **Save Number**.



- To save to a memory key, press  repeatedly until you see the memory key (M1-M4), and then press .

4. Keep or edit the name by taking one of these steps:

- To keep the current name exactly as it appears on the screen, press .
- To edit the name, press  beneath **Clear** on the screen, press alphanumeric keys to enter the name that you wish to store, and then press .

**Note:** You can press and hold to clear all letters at once.

5. Keep or edit the number by taking one of these steps:





- To keep the current number exactly the same, press .
- To edit the number, press  beneath **Clear** on the screen, press all alphanumeric keys that are required to place the call (1 and area code when required), and then press .

**Note:** You can press and hold to clear all numbers at once.



Default Ringtone, Record or Scroll appears on the screen, and the current ringtone or personal identifier plays.

## Phonebook

6. Save now or specify unique notification by taking one of these steps:

- **To save the information now** and assign a default ringtone: Press .
- **To record or re-record a personal identifier** to indicate calls from this person (Caller ID service required): Press  and scroll to **Record or scroll**, and then press . Press  to select **Start**, record an identifier, and then press .

Your recording plays, and Ring Tone Save? appears on the screen. Press  to save the recording.

- **To select a ringtone** to help indicate calls from this person (Caller ID service required): Press  and scroll to the tone of your choice, and then press .





7. Press .

## Copy entries from one handset to another





You can copy phonebook entries from one handset to another, in these ways:

- Copy individual entries
- Copy all entries: You can copy all and replace or you can copy all and add.

## To copy one phonebook entry from one handset to another







1. Press  beneath **Phnbk** on the screen.
2. Press the first alphanumeric key of the name that you wish to edit, and if necessary, press  and scroll to the name.
3. Press  to select **Option**.
4. Press  and scroll to **Copy Entry**, and then press .

A list of handsets that are connected to the base appears on the screen.

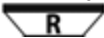

5. Press  and scroll to the handset to which you want to copy the entry, and then press .  
Copying to Hs (number) appears on the screen. On the destination handset, Receive Record? appears on the screen.
6. On the destination handset, press  to choose Select.
7. Press .

# Phonebook

To copy all phonebook entries from one handset to another



1. Press  beneath **Phnbk** on the screen.
2. Press  to select **Option**.
3. Copy all entries by taking one of these steps:
  - To copy all entries and *replace* existing entries: Press  and scroll to **Copy All**, and then press .
  - To copy all entries and *add to* existing entries: Press  and scroll to **Copy Append**, and then press .

A list of handsets that are connected to the base appears on the screen.

4. Press  and scroll to the handset to which you want to copy the entry, and then press .









Copying to Hs (number) appears on the screen.



On the destination handset, **Replace All Records?** or **Receive Record?** appears on the screen.

5. On the destination handset, press  to select **Select**.
6. Press .



## Edit a phonebook entry

1. Press  beneath **Phnbk** on the screen.
2. Press the first alphanumeric key of the name that you wish to edit, and if necessary, press  and scroll to the name.
3. Press  to select **Option**.
4. Press  and scroll to **Edit Entry**, and then press .
5. Keep or edit the name by taking one of these steps:
  - To keep the current name exactly the same, press .
  - To edit the name, press  beneath **Clear** on the screen, press alphanumeric keys to enter the name that you wish to store, and then press .





**Note:** You can press and hold to clear all letters at once.
6. Keep or edit the number by taking one of these steps:
  - To keep the current number exactly the same, press .
  - To edit the number, press  beneath **Clear** on the screen, press all alphanumeric keys that are required to place the call (1 and area code when required), and then press .

## Phonebook



**Note:** You can press and hold to clear all numbers at once.

Default Ringtone, Record or Scroll appears on the screen, and the current ringtone or personal identifier plays.

7. Save now or specify unique notification by taking one of these steps:







- **To save the information now** and assign a default ringtone: Press .
- **To record or re-record a personal identifier** to indicate calls from this person (Caller ID service required): Press  and scroll to **Record or scroll**, and then press . Press  to select **Start**, record an identifier, and then press .

Your recording plays, and Ring Tone Save? appears on the screen. Press  to save the recording.



- **To select a ringtone** to help indicate calls from this person (Caller ID service required): Press  and scroll to the tone of your choice, and then press .

8. Press .

## Delete one or all phonebook entries

1. Press  beneath **Phnbk** on the screen.
2. Press the first alphanumeric key of the name that you wish to edit, and if necessary, press  and scroll to the name.
3. Press  to select **Option**.
4. Delete one or all entries by taking one of these steps:
  - To delete one entry: Press  and scroll to **Delete Entry**, and then press .
  - To delete all entries: Press  and scroll to **Delete All**, and then press .

Delete Entry? or Delete All Entries?  
appears on the screen.

5. Press  to confirm.
6. Entry Deleted or All Entries Deleted  
appears on the screen.
7. Press .

# Memos

## Record a memo

You can record a memo from the base or from the handset. The memo can last up to three minutes, and anyone in the household can retrieve it from the base.

The answering machine records memos, even if the answering machine is set to Off.

### To record a memo from the base



1. Press and hold .

A voice prompt occurs, and **DTAM in Use** appears on the screen.







2. After the tone, speak clearly and loudly, and then press .

3. Press .

If the answering machine is turned On, **New Message (number)** flashes on the handset screen, and the flashing memos/messages count on the base screen increases by one.

## To record a memo from the handset



1. Press  beneath **Menu** on the screen.
2. Press  to select **Ans Machine**.
3. Press  and scroll to **Record Memo**, and then press .
4. After the tone, speak clearly and loudly, and then press .  
Saved appears on the screen.
5. Press .

If the answering machine is turned On, **New Message (number)** flashes on the handset screen, and the flashing memos/messages count on the base screen increases by one.

## Retrieve a memo

If the answering machine is turned on, **(Number) flashes** to indicate the number of unheard memos and answering machine messages. The handset screen always indicates an unheard memo as **New Message**.

If the answering machine is off, you can still hear unheard memos and messages. Memos and messages play in the order received.







You can use the answering machine base or the handset to retrieve memos.

# Memos

**Tip:** Delete old memos when possible. The answering machine has an 15-minute limit for memo and message storage. The base screen shows FL when memory is full. For instructions on deleting all memos and messages, see [page 106](#).

## To quickly retrieve a memo, using the base speakerphone



1. Press and hold .  
If unheard memos or answering machine messages are stored, only those memos and messages play. Otherwise, all stored memos and messages play.
2. (Optional) Adjust message playback:
  - To adjust volume: Press  or .
  - To replay a memo or message: Press .
  - To pause and unpause during playback: Press and hold .
  - To skip ahead to the next memo or message: Press .

- To delete a memo or message:  
During playback, press  .

- To stop the announcements, press



## To retrieve a memo, using the handset





Messages play on the handset speakerphone, but you can turn off the speaker if you prefer to listen discretely.



1. Play only new or play all memos and messages:







- To play only new memos and messages:  
Press  beneath **Play** on the screen.

**Note:** **Play** appears on the screen only if there are unheard memos or messages.

- To play all memos and messages:
  - a. Press  beneath **Menu** on the screen.
  - b. Press  to select **Ans Machine**.
  - c. Press  and select **Play Message**.
  - d. Press  and scroll to **Play All**, and then press .

# Memos

## 2. (Optional) Adjust playback:

- To turn off the speaker: Press .
- To adjust the volume: Press  on the side of the handset.
- To replay a memo or message: Press .
- To pause and unpause during playback:  
Press .
- To skip ahead to the next memo or message:  
Press  beneath **Next** on the screen.
- To delete a memo or message: During playback, press  beneath **Erase** on the screen.
- To stop the announcements: Press .









# Answering and calling

## Auto answering

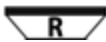
By default, you answer calls by removing the handset from the base and pressing .

If you prefer to answer calls by simply removing the handset from the base, you can turn on the auto answer feature for the handset. If the handset rings when it is off of the base, you must still press  to answer the call.

## To turn on or off auto answering









1. Press  beneath **Menu** on the screen.
2. Press  and scroll to **Setting**, and then press .
3. Press  and scroll to **Auto Answer**, and then press .
4. Press  and scroll to **On** or **Off**, and then press .
5. Press .

## Answering and calling

### To turn on or off auto answering for internal (intercom) calls

You can set auto answering for calls from other handsets that are registered to your ClearSounds A500 base.

If Internal Auto Answer is on, intercom call recipients simply hear the caller through the speakerphone while the handset rests on the base. The phone does not ring.







1. Press  beneath **Menu** on the screen.
2. Press  and scroll to **Setting**, and then press .
3. Press  and scroll to **Int auto answer**, and then press .
4. Press  and scroll to **On** or **Off**, and then press .
5. Press .

## Answer, place or end a call

These instructions also apply under these conditions:

- Using a handset connected to a headset.
- Answering and ending an intercom call. A handset display indicates an incoming intercom call with  and the caller's handset number. For instructions on placing an intercom call, see [page 78](#).

### To answer, place or end a call

Answer	Place	End
<p>1.  Lift.</p> <p>2. Press .</p> <p><b>Note:</b> If you set the handset to auto answer, simply lift the handset from the base. For instructions to set auto answer, see <a href="#">page 71</a>.</p>	<p>1.  Lift.</p> <p>2. Dial .</p> <p>3. Press .</p> <p> appears on the screen.</p>	<p>1. Press .</p> <p>Call duration appears on the screen.</p>

## Answering and calling

### Silence a ringing handset

You can stop a handset from ringing during an incoming call.

#### To silence a ringing handset

- Press  beneath **Silent** on the screen



### Place a one-touch call

If you have stored numbers in the memory keys, you can call these numbers with one touch.

If you need instructions for storing one-touch numbers, see [page 53](#).

#### To place a one-touch call





1. Lift .
2. Press and hold the  -  that you wish to call.  
The memory information appears on the screen, and the phone dials.

## Redial a number

You can quickly redial any of the last ten numbers that were dialed from your handset.





### To redial the last-dialed number



1. Lift .
2. Press .  
The last-dialed number appears on the screen.
3. Press .  
The phone dials.

### To redial a recently dialed number



1. Lift .
2. Press .  
The last-dialed number appears on the screen.
3. Press  and scroll to your selection, and then press .  
The phone dials.

## Answering and calling





### Call from your phonebook

If you have stored a number in your phonebook, you can call it quickly.

If you need instructions for storing phonebook numbers, see [page 56](#).

### To call a phonebook number



1. Lift .
  2. Press  beneath **Phnbk** on the screen.  
The first alphabetic listing appears on the screen.
  3. Find the desired name by taking one of these steps:
    - Press the key for the first letter of the first name shown in the listing, and if necessary, press  and scroll to your selection.
    - Press  and scroll to your selection.
  4. Press .
- The phone dials.

## Call from the inbound calls list

If you subscribe to caller ID service with your telephone service provider, the handset stores the last 30 calls made to your telephone. You can quickly dial any of the numbers stored in the list.







The inbound calls list includes these entries:

- Received calls
- Missed calls
- Voicemail messages (voicemail service required)

**Note:** If area codes are not required for local calls in your region, see [page 28](#) for instructions on specifying that the phone not save the area code in lists.

### To call from the inbound calls list



1. Lift .
2. Press .  
The most recent inbound call appears on the screen.
3. Press  and scroll to your selection.
4. (Optional) To add your local area code, press .  
To add or remove a 1, press .
5. Press .  
The phone dials.



## Answering and calling

### Call other handsets in your home (intercom)

If additional handsets are registered to your ClearSounds A500 base, you can place internal calls among the handsets.

**Note:** If an external call comes in while you converse on an internal call, press  to end the internal call before you answer the external call.

### To place an intercom call

1. Lift .
2. Press .  
Internal\_ appears on the screen.
3. Press the handset number of the phone that you wish to call.
4. To end the call, press .





## During calls

### Adjust sound

Use these controls to adjust earpiece sound during a call. After you hang up, volume and tone equalizer settings remain set for the next call.

Amplification resets to off when a call ends. If you prefer to set amplification always on, see [page 34](#).

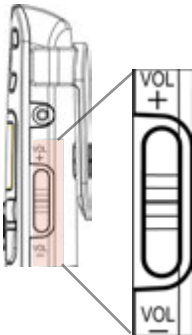
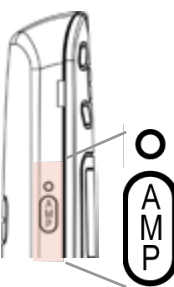
### To adjust the handset volume and tone during a call

Volume	Amplify	Equalize tone
 <ul style="list-style-type: none"><li>• Press + or -.</li></ul>	 <ul style="list-style-type: none"><li>• Press to turn on or off.</li></ul>	<ol style="list-style-type: none"><li>1. Press .</li><li>2. Press  to select Treble, Flat or Bass. As you select, a graph appears on the screen.</li></ol>

## During calls

### Use the speakerphone

If you remain close to the base or handset, you can converse handsfree and listen over the handset speakerphone.

To enjoy optimal speakerphone performance, locate the handset away from areas with high background noise.



**Note:**  does not work in the speakerphone mode.

### To turn on the handset speakerphone during a call

1. Press .

The handset speakerphone is on, and  appears on the screen.

2. Place the handset on a nearby surface, standing up.
3. (Optional) Accomplish these tasks as usual:
  - Adjust volume
  - Equalize tone
  - Mute the microphone

4. To turn off the speakerphone: Press .



5. To end the call, press .

## Mute the microphone

You can mute the handset so that the other party cannot hear any noise or conversation on your end of the line. You can still hear the other party.

Muting also works when you use a speakerphone or headset.





### To mute and unmute the handset microphone

1. Press  beneath **Mute** on the screen.  
Mute On flashes on the screen.
2. To turn off muting and return to conversation, press  beneath **Off**.

## Transfer a call

You can transfer a call to another handset that is registered to the same base.

### To transfer a call to another handset

1. During a conversation with an outside caller, press .  
The caller with whom you were speaking is on hold.
2. Press the numeric key that indicates the number of the handset that you wish to call.  
 and your handset number appear on the recipient's display.
3. After the recipient answers the call, press  beneath **CONF** on the screen.  
The three parties are connected.
4. Press  to leave the call.  
The other parties remain connected.

## During calls

### Use a headset

You can plug in a headset to the handset and converse handsfree while listening discretely through the headset. You can connect the headset before or during a call.

### To use a headset

If the headset includes a microphone, you can attach the handset clip to your belt or clothing: you are mobile!

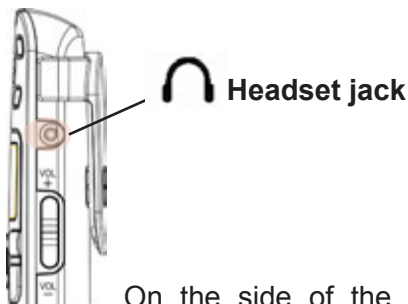





1. On the side of the handset, connect the headset to the jack.
2. Place the headset on your head.
3. (Optional): Clip the handset to your belt or clothing.
4. Accomplish these tasks as usual:
  - Answer or place calls
  - Adjust and amplify volume
  - Equalize tone
  - Mute the microphone
  - End calls



## Set up a conference call

You can set up a three-party call with an external caller and a person using an A500 handset that is registered to your base.

### To set up a conference call

1. During a conversation with an outside caller, press .  
The caller with whom you were speaking is on hold.
2. Press the numeric key that indicates the number of the handset that you wish to call.  
 and your handset number appear on the recipient's display.
3. After the recipient answers the call, start the conference or return to the external caller.
  - To start the conference, press  beneath **CONF** on the screen.  
The three parties are connected.
  - To return to the external caller without starting a conference call, press .

### To leave a conference call

- Press .
- The other parties remain connected until they press .

## Answering machine adjustments

### Is the answering machine right for you?

The phone includes a built-in answering machine. You must choose one method as a primary message retrieval method: answering machine or voicemail.

Each method has unique features and benefits.

#### Answering machine

- Call screening: You can hear the caller leave a message and pick up the handset to speak.
- One-touch message retrieval ()
- Holds 15 minutes of messages and memos.

#### Voicemail service

- Purchased through your telephone service provider
- If you add caller ID service, detects and stores a record of incoming calls and messages that come through, even when your line is engaged.
- If you add call waiting service, notifies you of incoming calls when the line is engaged.

### Answering machine with call waiting

If you prefer using an answering machine, but you also want to be alerted to incoming calls when you are on the line with another caller, you can primarily use the answering machine and purchase voicemail with the caller ID on call waiting feature.



If you do not answer the second caller and the caller leaves a message, the message becomes a voicemail.

To set up your phone in this way, you must set the number of “rings before pickup” for the answering machine to be less than the number of rings before voicemail pickup. The number of rings before voicemail pickup is determined when you set up voicemail with your service provider.

For instructions on setting the answering machine ring pickup number, see [page 93](#).

## Turn on or off the answering machine

The answering machine records incoming messages and memos. The answering machine factory default is off.

You must turn on the answering machine to record messages, but you can record memos even if the answering machine is turned off.

When the answering machine is on, the base screen shows the number of stored messages (red digits).

You can turn on or off the answering machine simply at the base, or through the handset menus.

## Answering machine adjustments

To turn on or off the answering machine, using the base









- Press .

On the base screen, digits indicate that the answering machine is on.



To turn on or off the answering machine, using the handset



1. Press  beneath **Menu** on the screen.
2. Press  to select **Ans Machine**
3. Press  and scroll to **Ans On/Off**, and then press .
4. Press  and scroll to your choice, and then press .

Save d appears on the screen.

5. Press .

On the handset screen,  indicates answering machine on, and  indicates answering machine off.



## Record a personalized greeting

By default, the answering machine greeting is "Hello. Your call cannot be taken at the moment. So please leave your message after the tone."



You can replace the default greeting by recording a personalized greeting that is as long as two minutes.

You can record your greeting simply at the base, or through the handset menus.

**Note:** If you are unable to record, delete some or all of the stored messages.

### To record a personalized greeting, using the base









- Press and hold , speak to record your message after the tone, and then press . Your recording plays.

## Answering machine adjustments

To record a personalized greeting, using the handset



1. Press  beneath **Menu** on the screen.
2. Press  to select **Ans Machine**.
3. Press  and scroll to **Outgoing Msg**, and then press .
4. Press  to select **Record Message**.
5. After the tone, speak to record your message, and then press .  
Your recording plays.
6. Accept the recording, or re-record:
  - To accept the recording, press .
  - To re-record, begin again at Step 4.

## Listen to your greeting

You can use the base or the handset to listen to your current greeting.







### To listen to your greeting, using the base

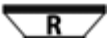

- Briefly press .

### To listen to your greeting, using the handset





1. Press  beneath **Menu** on the screen.
2. Press  to select **Ans Machine**.
3. Press  and scroll to **Outgoing Msg**, and then press .
4. Press  and scroll to **Play Message**, and then press .  
Your recording plays.
5. Accept the recording, or re-record:
  - To accept the recording, press .
  - To re-record, scroll to and select **Record Message**, and follow the prompts.

## Answering machine adjustments

### Restore the default message

You can restore the phone's default greeting by erasing a personalized greeting.

#### To restore the default greeting

1. On the base, briefly press .
2. As the current greeting plays, press and hold  until you hear "Outgoing message deleted."  
The default outgoing message is restored.

### Personalize your remote access security code

You can call your phone from a touch-tone phone or cell phone at a remote location and enter your remote access security code to retrieve your messages. (If you are interested in answering machine remote access instructions, see [page 104](#).)

The default remote access security code is 000, but you can create a personal code.

You can use the base or handset to set the code.

## To hear the current remote access security code

If you cannot recall your personal security code, you can hear it by pressing a button on the answering machine base.

1. On the base, press and hold



The voice prompt tells you the current security code, and tells you to please set the first number.

Do not enter numbers.

2. Wait for the display to return to the two-digit display (the number of stored messages).

## To personalize your remote access security code, using the base



1. Press and hold



The voice prompt tells you the current security code, and tells you to please set the first number.

2. Press or until you see your desired first number on the screen.







## Answering machine adjustments

3. Repeat Steps 1 and 2 until you see your desired second number on the screen.
4. Repeat Steps 1 and 2 until you see your desired third number on the screen.  
A tone occurs, and the voice prompt reads the new security code.

### To personalize your remote access security code, using the handset

Note: You must enter your current security code before you can change the code. If you do not recall the code, you can retrieve it from the answering machine base (for instructions, see [page 91](#)) The factory default code is 000.



1. Press  beneath **Menu** on the screen.
  2. Press  to select **Ans Machine**.
  3. Press  and scroll to **Ans Settings**, and then press .
  4. Press  and scroll to **Security Code**, and then press .
- 01d PIN: appears on the screen.

5. Press the numeric keys to enter the current three-digit security code, and then press **OK**.  
New PIN: appears on the screen.
6. Press the numeric keys to enter the new three-digit security code, and then press **OK**.  
Again appears on the screen.
7. Repeat Step 6.  
DTAM PIN changed appears on the screen.

## Change the number of rings before pickup

By default, your answering machine picks up calls after the third ring. You can use the base or the handset to change this setting.

You can set it to pick up after two, three, four, five, six, seven, eight or nine rings.

If you would like the machine to pick up after five rings but after two if new messages are waiting, select Toll Saver (TS). Toll Saver is helpful in this way: If you check messages from a remote, long-distance location, and the machine doesn't pick up after two rings, you know that there are no new messages. You can hang up and avoid incurring a long-distance fee.

## Answering machine adjustments



If you use the answering machine together with voicemail and call waiting service, you must set the number of rings before pickup to be less than the number of rings before pickup for voicemail service. Voicemail pickup is determined by your service provider. For more information, see [page 84](#).

### To change the number of rings before pickup, using the base



1. Press and hold

The prompt shows and tells you the current ring delay, and tells you to please set new delay.

2. Press  or  until you see your desired number on the screen.









3. Briefly press  until a tone

occurs and the voice prompt reads the new ring delay.

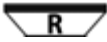

## To change the number of rings before pickup, using the handset



1. Press  beneath **Menu** on the screen.
2. Press  to select **Ans Machine**.
3. Press  and scroll to **Ans Settings**, and then press .
4. Press  to select **Answer Delay**.  
The current setting is highlighted on the screen.
5. Press  or  and scroll to your choice, and then press . **Saved** appears on the screen.
6. Press .

## Voicemail and inbox

If you subscribe to Voicemail and Caller ID services with your telephone service provider, the handset stores the last 30 calls made to your telephone in the inbound calls list.

### Screen a call

#### To visually screen during a voicemail message

If you subscribe to caller ID, you see the caller's name and number on the handset screen under either of these conditions:

- If your phonebook contains an entry for the caller
- If the caller and telephone service make them available

### Intercept a call waiting call

If you subscribe to call waiting service and you are having a phone conversation, you can intercept an incoming call and switch between the two parties. The waiting party remains on hold until he or she disconnects.

#### To intercept an incoming call waiting call

1. Tell the first caller that you are putting him or her on hold.



2. Press  (call waiting), and speak to the new caller.





3. To reconnect with the first caller, press .

## Visual indicators of calls and voicemail

The handset provides these visual indicators.

### Handset call and voicemail indicators

Visual indicator	Meaning	Clear it
X New Calls	The number of non-viewed calls  If the same person calls more than once, the number lists the caller only once, and the call is marked "rep" for "repeat."	Scroll through all Caller ID entries that are marked "new."
 Flashes	One or more non-viewed, missed calls	
	One or more unprocessed voicemail messages	Listen to all unheard voicemail messages, and delete or save them.

# Voicemail and inbox

## Review inbound calls

The handset lists most recent calls first.

### To scroll through missed calls

1. Press .

2. Repeat for the next listing.

Each listing shows this information:

- Caller name and number (when available)
- Date and time of the call
- **n e w** (non-reviewed calls), **o l d** (previously reviewed calls) or **r e p** (repeated calls)

## Listen to voicemail messages

If you have unheard voicemail messages, when you open the line to make a call, you hear a stutter dial tone.

### To listen to voicemail messages

- Call your voicemail access number, as specified by your telephone service provider.

If you are interested in storing your voicemail access number for one-touch calling, see [page 58](#) for instructions.

# Machine messages

## Screen a call

If you hear a caller leaving an answering machine message, you can discreetly hear the caller through the handset instead of through the base speakerphone.

### To screen during an answering machine message



1. When you see **DTAM** in use on the screen, lift .

2. Press .

**Call Screening** appears on the screen.

The answering machine continues recording, and the caller does not hear you listening.

## Intercept a call during an incoming message

If you hear a caller leaving an answering machine message, and you want to speak to the caller, you can intercept and speak to the caller.

### To intercept during an incoming message



1. Lift .

2. Press  beneath **Talk** on the screen.



The answering machine stops recording.

# Machine messages

## Visual indicators of messages

When the answering machine is turned on, it holds 15 minutes of messages and memos, and it indicates unheard messages.

## Answering machine message indicators

	Indicator	Clear it
	<b>XX (flashing)</b> (XX=number of new messages)  <b>XX (non-flashing)</b> (XX=number of retrieved and stored messages)	Listen on the base or handset to all unheard messages.  Delete all of the messages.
	<b>New Message: XX (flashing)</b> (XX=number of new messages)	Listen on the base or handset to all unheard messages.

## Listen to answering machine messages

You can listen to answering machine messages on the base or on the handset. The messages play in the order received.

## To listen to answering machine messages, on the base







Messages play on the base speakerphone.



1. Press 

If unheard messages or memos are stored, only those messages or memos play. Otherwise, all stored messages and memos play.

2. (Optional) Adjust playback:

- To adjust volume: Press  or .
- To skip ahead to the next message or memo: Press .
- To replay a message or memo: Press .
- To pause and unpauses during playback: Press and hold .
- To delete a message or memo: During playback, press  and hold for two seconds.
- To stop the announcements, press .

## Machine messages

### To listen to answering machine messages, on the handset





Messages play on the handset speakerphone, but you can turn off the speaker if you prefer to listen discretely.



1. Play only new or play all messages and memos:







- To play only new messages and memos: Press  beneath **Play** on the screen.

**Note:** **Play** appears on the screen only if there are unheard messages or memos.

- To play all messages and memos:
  - a. Press  beneath **Menu** on the screen.
  - b. Press  to select **Ans Machine**.
  - c. Press  and select **Play Message**.
  - d. Press  and scroll to **Play All**, and then press .



2. (Optional) Adjust playback:

- **To turn off the speaker:** Press 
- **To adjust volume:** Press  on the side of the handset.
- **To replay a message or memo:** Press .
- **To pause and unpause:** Press .
- **To skip ahead to the next message or memo:** Press  beneath **Next** on the screen.
- **To delete a message or memo:** During playback, press  beneath **Erase** on the screen.
- **To stop the announcements:** Press .



## Machine messages

### To access the answering machine remotely

You can access your answering machine remotely by dialing your phone number from any touch-tone phone or cell phone.

Through remote access, you can play and delete messages, record a new greeting and turn off or on the answering machine.

Remote access requires a remote access security code. The default code is 000. If you are interested in instructions for personalizing the code, see [page 90](#).

1. From any touch-tone phone, dial your phone number.
2. Wait for the message to play and the beep to occur, and then press  . You are prompted to enter the remote access code.
3. After the prompt is complete, press numeric keys to enter your remote access code.

A short beep occurs.

4. Follow the prompts:

Press	Result
2	Listen to messages
1	Previous message
2	Pause and unpause
3	Next message
7	Erase playing message
#	Record a memo
6	Stop recording the memo
4	Play the current greeting
5	Record a new greeting
6	Stop recording the greeting
0	Erase all retrieved messages
8	Turn off the answering machine
9	Turn on the answering machine <b>Note:</b> If you use the answering machine together with voicemail service, you cannot remotely turn on the answering machine.

5. When you are finished, disconnect the call.

# Machine messages

## Delete machine messages and memos

It is important to delete old messages and memos on your answering machine, to make space for new messages. You can delete only reviewed (old) messages and memos.

The machine holds 15 minutes of messages. If the machine is full, the caller cannot record a new message, and the base shows FL.

### To delete one machine message or memo



1. While the message is playing, press  and hold for two seconds.

You hear "Message erased."

### To delete all reviewed machine messages and memos, using the base







1. Press  and hold for two seconds .

You hear "To delete all old messages, press Delete."

2. Briefly press  .

## To delete all reviewed machine messages and memos, using the handset



1. Press  beneath **Menu** on the screen.
2. Press  to select **Ans Machine**.
3. Press  and scroll to **Delete Msgs**, and then press .

Delete All Old? appears on the screen.

4. Press .
- All Old Deleted appears on the screen.

## List maintenance

The ClearSounds A500 phone stores two lists:



- **Dialed calls list:** The last 10 numbers that were called from your handsets.
- **Inbound calls list** (Caller ID service required) The last callers who called you. Each handset stores 30 calls.

### Delete entries from lists

The oldest call automatically drops from the list when the list is full. You can remove calls manually if you wish.





#### To delete calls from dialed or inbound calls lists

1. Search a list by taking one of these steps:

- To delete numbers from the dialed calls list: press  repeatedly until you see a call that you want to delete.
- To delete numbers from the inbound calls list: press  repeatedly until you see a call that you want to delete.

2. Press  to select **Option**.

3. Delete one or all entries in the list:

- To delete only the selected entry, press  and scroll to **Delete**, and then press .
- To delete all entries in the list, press  and the press  to select **Delete All**. Press  to confirm.

4. Press .

# Security

## Personalize the system PIN



You must enter the system personal identifier number (PIN) to restore handset default settings or to register and unregister an additional handset to the base.

This section instructs you on how to change from the default system PIN to a personalized PIN. The factory default system PIN is 0000.



**Note:** Carefully consider whether a personalized system PIN is necessary. If you are concerned that you might forget your personalized system PIN, store a record of it in a secure location. If you cannot recall or find your personalized system PIN, you cannot perform functions that require it.

Personalizing the remote access code for the answering machine is discussed in another section. If you are interested in the answering machine remote access code, see [page 90](#).

### To personalize the system PIN

1. Press  beneath **Menu** on the screen.
2. Press  and scroll to **Setting**, and then press .

## Security

3. Press  and scroll to **System PIN**, and then press .

Old PIN: appears on the screen.

4. Press numeric keys to enter the present PIN, and then press .

**Note:** The factory default PIN is 0000.

New PIN: appears on the screen.

5. Press numeric keys to enter the new PIN, and then press .

Again: appears on the screen.

6. Press numeric keys to re-enter the new PIN, and then press .

A confirmation tone occurs and PIN Changed appears on the screen.

7. Press .



# Restoring defaults

## Restore handset default settings





You can reset your handset to factory default settings.

These settings are saved (they do *not* reset):

- Incoming calls list (Caller ID)
- Dialed calls list
- Phonebook entries

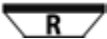
You must enter the system PIN to reset the defaults. The PIN is 0000.

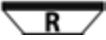
### To restore handset default settings

1. Press  beneath **Menu** on the screen.
2. Press  and scroll to **Setting**, and then press .
3. Press  and scroll to **Handset Reset**, and then press .  
Handset Reset? appears on the screen.
4. Press .

**Note:** The factory default PIN is 0000.

New PIN: appears on the screen.

## Restoring defaults

5. Press numeric keys to enter the new PIN, and then press .

Again: appears.

6. Press numeric keys to re-enter the new PIN, and then press .

A confirmation tone occurs and PIN Changed appears on the screen.

7. Press .

## Additional handsets



### Register additional handsets to the base

Your telephone handset (Handset 1) is registered to the base.

If you purchased additional ClearSounds A500E handsets, you must register each additional handset to the ClearSounds A500 base. The base can accommodate a total of five handsets.

Each handset's registration number appears on the handset's home screen.

### To register an additional handset to the base

1. On the unregistered A500E handset, press and hold  beneath **Menu** on the screen, until **Press and hold base Page key** appears, and then release the handset key.
2. On the base, press and hold  for 10 seconds, and then release the key.

When the handset is registered to the base, the handset number appears on the handset screen.









## Additional handsets

### Delete a handset registration

You can delete a handset registration from the base.

**Note:** To accomplish this task, you cannot use the handset that you are deleting. You must use an alternate handset.

#### To delete a handset registration

1. Press  beneath **Menu** on the screen.
2. Press  and scroll to **Setting**, and then press .
3. Press  and scroll to **Unregister**, and then press .
4. Press numeric keys to enter the system PIN code (0000 is the factory default code), and then press .
5. Press numeric keys to enter the number of the handset that you wish to unregister, and then press .
6. Press .

# Troubleshooting

## General operation

Symptom	Solutions
Phone is non-operational.	<ul style="list-style-type: none"><li>• Secure the power adapter connection in the AC wall outlet and in the handset jack.</li><li>• Secure the phone line cord in the wall jack and in the handset jack.</li><li>• Fully charge the handset batteries and install them properly.</li><li>• Plug in another phone to the same wall jack to ensure that the phone service is operational.</li></ul>
Handset batteries seem to have short lives.	<ul style="list-style-type: none"><li>• Use only AAA NiMH rechargeable batteries. Never use alkaline batteries!</li><li>• Clean the charging contacts.</li></ul>
When I lift the handset from the base, the line does not open.	<ul style="list-style-type: none"><li>• Turn on the auto answer feature (<a href="#">page 71</a>).</li></ul>

## Troubleshooting

Symptom	Solutions
There is noise, static or interference.	<ul style="list-style-type: none"><li>• If you subscribe to DSL service, install a DSL filter (<a href="#">page 16</a>).</li><li>• Plug in the power adapter to the wall outlet and securely connect it to the phone.</li><li>• Do not plug in other appliances to the same wall outlet.</li><li>• Move the phone to a location that is free of interference.</li><li>• If you are located near radio towers, install a filter.</li></ul>
On the handset, <b>Y</b> is blinking, <b>Searching</b> appears and a tone is sounding.	<ul style="list-style-type: none"><li>• The handset is out of range of the base. Move the handset closer to the base.</li></ul>
I cannot recall my system PIN.	<ul style="list-style-type: none"><li>• The factory default system personal identifier number (PIN) is 0000. If you personalized it, you must enter the personalized number. See <a href="#">page 109</a>.</li></ul>

## Voicemail and call waiting services

Symptom	Solutions
Call waiting does not work.	<ul style="list-style-type: none"><li>• Confirm with your service provider that you subscribe to call waiting service.</li><li>• If another handset is engaged on the line, call waiting information doesn't show.</li></ul>
There is no caller ID information on the screen.	<ul style="list-style-type: none"><li>• Confirm that you subscribe to caller ID service.</li><li>• For information while you are conversing, confirm that you subscribe to caller ID on call waiting service.</li><li>• Some callers or providers withhold details.</li><li>• ID information can be delayed: Check after the phone rings a few times.</li></ul>



# Troubleshooting

## Call notification

Symptom	Solutions
There is no audible ringer.	<ul style="list-style-type: none"><li>• Turn on the ringer and turn up the ringer volume (<a href="#">page 46</a>).</li><li>• Plug in the power adapter to the wall outlet and securely connect it to the phone.</li><li>• Unplug one or more devices that share the phone line.</li></ul>



## Dialing

Symptom	Solutions
A memory button does not function.	<ul style="list-style-type: none"><li>• Program the number (<a href="#">page 53</a>).</li></ul>
Area codes or the long distance code are missing from lists, or they are there and I don't need them for local calls.	<p>The phone dials the exact number that you see on the screen.</p> <ul style="list-style-type: none"><li>• If you are calling from a memory key or the phonebook, be sure that you have stored required area codes and long distance codes. See <a href="#">page 48</a> and <a href="#">page 56</a>.</li><li>• When dialing out using a number from the inbound calls list, press  to add or delete a 1, and press  to add the local area code.</li><li>• If local calls do not require an area code in your region, see "<a href="#">Call storage: local area code</a>" on <a href="#">page 28</a>.</li></ul>

# Troubleshooting





## Audio

Symptom	Solutions
Low handset earpiece or speakerphone volume, or poor tone	<ul style="list-style-type: none"><li>• Plug in the power adapter to the wall outlet and securely connect it to the phone.</li><li>• Turn up the volume and amplification settings (<a href="#">page 34</a>)</li><li>• By default, amplification turns off after each call. If you prefer it on consistently, turn it on (<a href="#">page 34</a>).</li><li>• Adjust bass, flat and treble tone equalizer (<a href="#">page 79</a>).</li></ul>

## Phonebook

I have two handsets registered to the base, and each one has unique stored phonebook entries. I wanted to add entries from Handset 1 to Handset 2, so I copied phonebook entries, but the original entries on Handset 2 were lost.	<ul style="list-style-type: none"><li>• You selected <b>Copy All</b> instead of <b>Copy Append</b>. See <a href="#">page 62</a>.</li></ul>
--	--

## Answering machine

Symptom	Solutions
<p>When listening to messages, volume is too low or too high.</p>	<p><b>During listening:</b></p> <div style="display: flex; justify-content: space-around; align-items: center;">   </div> <ul style="list-style-type: none"> <li>• <b>Base:</b> Adjust on the base.</li> </ul> <div style="display: flex; justify-content: space-around; align-items: center; margin-top: 10px;">   </div> <ul style="list-style-type: none"> <li>• <b>Handset:</b> Volume: Adjust on the side of the handset.</li> </ul> <p><b>Tone:</b> Press  until you hear the tone that you prefer.</p> <p><b>Consistent handset settings:</b></p> <ul style="list-style-type: none"> <li>• Amplification (<a href="#">page 34</a>).</li> </ul>
<p>Incomplete caller messages occur.</p>	<p>The memory is full. Delete some or all messages (<a href="#">page 106</a>).</p>
<p>I cannot recall my remote access security code.</p>	<p>The default code is 000. If you personalized the code, you can hear the current personalized code (<a href="#">page 91</a>).</p>

# Compliance

## U.S. Federal Communications Commission (FCC)

FCC ID: WG8A500

US:CLSW400BA500

### FCC Caution

Any changes or modification not expressly approved by the party responsible for compliance could void the user's authority to operate the equipment.

This device complies with Part 15 of the FCC rules. Operation is subject to the following two conditions:

1. This device may not cause harmful interference.
2. This device must accept any interference received, including interference that may cause undesired operation.

### FCC wants you to know

1. This equipment complies with Part 68 of the FCC rules and the requirements adopted by the ACTA. On the bottom of this equipment is a label that contains, among other information, a product identifier of [US: AAAEQ##TXXXX]. If requested, this number must be provided to the phone company.
2. The plug and jack used to connect this equipment to the premises wiring and telephone network must comply with the applicable FCC Part 68 rules and



requirements adopted by the ACTA. A compliant telephone cord and modular plug are provided with this product. It is designed to be connected to a compatible modular jack that is also compliant. See installation instruction for details.

3. If the ClearSounds® A500 DECT 6.0 Amplified Phone causes harm to the phone network, the phone company will notify you in advance that temporary discontinuance of service may be required. But if advance notice isn't practical, the phone company will notify the customer as soon as possible. Also, you will be advised of your right to file a complaint with the FCC if you believe that it is necessary.
4. The phone company may make changes in its facilities, equipment, operations or procedures that could affect the operation of the equipment. If this happens, the phone company will provide advance notice in order for you to make necessary modifications to maintain uninterrupted service.
5. If you experience trouble with the ClearSounds A500 DECT 6.0, you should disconnect it from the network until the problem has been corrected or until you are sure that the equipment is not malfunctioning.
6. Please follow instructions for repair, if any (e.g. battery replacement section); otherwise do not alter or repair any parts of the device, except as specified. For repair procedures, follow the instructions outlined under the limited warranty.

## Compliance

7. Connection to party line service is subject to state tariffs. Contact the state public utility commission, public service commission or corporation commission for information.
8. If your home has specially wired alarm equipment connected to the phone line, ensure that the installation of the ClearSounds A500 DECT 6.0 does not disable alarm equipment. If you have questions about what will disable alarm equipment, consult your phone provider or a qualified installer.
9. If the phone company requests information on what equipment is connected to their lines, inform them of the following:
  - a. Phone number to which this unit is connected
  - b. Ringer equivalence number (REN) [0.0]
  - c. USOC jack required [RJ11C]
  - d. Facility interface codes (FIC) [02LS2]
  - e. Service order codes (SOC) [9.0Y]
  - f. FCC Registration Number [US:CLSW400BA500]
10. The ringer equivalence number (REN) is used to determine how many devices can be connected to your phone line. If too many devices are attached, they may not ring in response to an incoming call. In most but not all areas, the sum of the RENs of all devices on any one line should not exceed five (5.0). To be certain of the number of devices that may be connected to your line, as determined by the total RENs, contact your local telephone company. The REN for this product is part of the product identifier that has the format



US:AAAEQ##TXXXX. The digits represented by ## are the REN without a decimal point. For this product the FCC registration number is US:CLSW400BA500, which indicates the REN would be 0.0.

## Service Requirements

In the event of ClearSounds A500 DECT 6.0 equipment malfunction, all repairs should be performed by ClearSounds or an authorized agent. It is the responsibility of users requiring service to report the need for service to ClearSounds or to one of our authorized agents. If the equipment is causing harm to the telephone network, the telephone company may request that you disconnect the equipment until the problem is resolved.

Service can be facilitated through our office at:

ClearSounds Communications, Inc.  
1743 Quincy Avenue, Suite 155  
Naperville, IL 60540  
Tel: 1-800-965-9043  
Fax: 1-630-654-9219

## Industry Canada

This device IC is 7800A-CSA500.

## CS03 Statement

This product meets the applicable Industry Canada technical specifications. This is confirmed by the registration number. The abbreviation, IC before the registration

## Compliance

number signifies that registration was performed based on a Declaration of Conformity indicating that Industry Canada technical specifications were met. It does not imply that Industry Canada approved the equipment.

Before installing this equipment, users should ensure that it is permissible to be connected to the facilities of the local telecommunications company. The equipment must also be installed using an acceptable method of connection. The customer should be aware that compliance with the above conditions may not prevent degradation of service in some situations.

Repairs to certified equipment should be made by an authorized Canadian maintenance facility designated by the supplier. Any repairs or alterations made by the user of this equipment, or equipment malfunctions, may give the telecommunication company cause to request the user to disconnect the equipment.



**WARNING:** Users should not attempt to make such connections themselves, but should contact the appropriate electric inspection authority, or an electrician, as appropriate.



**CAUTION:** The Ringer Equivalence Number (REN) assigned to each terminal device provides an indication of the maximum number of terminals allowed to be connected to a phone interface.

The termination on an interface may consist of any combination of devices subject only to the requirement that the sum of the Ringer Equivalence Numbers of all the devices



does not exceed 5. An alternative indication of the REN is the Load Number (LN); this number should be divided by 20 to approximate the equivalent REN. The REN of this unit is indicated on the bottom of your phone.

### RSS (category 1 equipment)

This device complies with Industry Canada license-exempt RSS standard(s). Operation is subject to the following two conditions:

1. This device may not cause interference.
2. This device must accept any interference that may cause undesired operation of the device.

Under Industry Canada regulations, this radio transmitter may only operate using an antenna of a type and maximum (or lesser) gain approved for the transmitter by Industry Canada. To reduce potential radio interference to other users, the antenna type and its gain should be so chosen that the equivalent isotropically radiated power (e.i.r.p.) is not more than that necessary for successful communication.

### Important note

#### **Radiation Exposure Statement:**

This equipment complies with radiation exposure limits set forth for an uncontrolled environment. This equipment should be installed and operated with minimum distance of 20cm between the base and your body. This transmitter must not be co-located or operating in conjunction with any other antenna or transmitter. Privacy of communications may not be ensured when using this telephone.

## Warranty

Be sure to save your sales receipt as the proof of purchase date should you need warranty service. The serial number for this product is on the underside of the base.

Your ClearSounds A500 DECT phone and A500E phone come with a (1) year limited warranty from the date of purchase. These products are warranted by ClearSounds against manufacturing defect in material and workmanship under normal use. In the event that this product fails to function properly due to defects in materials or workmanship within one year of the original purchase, return the unit (freight prepaid) with proof of purchase (sales receipt or packing slip, no exceptions) to ClearSounds Communications. ClearSounds Communications will either repair or replace the unit (with a refurbished unit or unit of equal condition) and return it you (using UPS/USPS ground shipping) at no cost to you. The warranty replacement or repair will be warranted for a period of 90 days or the remainder of the original warranty period (from original purchase date), whichever is longer.

The warranty does not cover accidents, negligence or breakage to any parts. This includes shipping damage, failure to follow instructions, misuse, fire, floods, use of incompatible accessories, acts of God or failure in your phone service carrier's line service. The product must not be tampered with or taken apart by anyone who is not an authorized ClearSounds Communications® representative. Tampering with the phone will void any written or implied warranties.



If a defect covered by this warranty should occur, promptly contact a Customer Service representative by phone, or log on to [www.clearsounds.com](http://www.clearsounds.com) to obtain a Return Merchandise Authorization (RMA) number and shipping instructions before shipping the product to us. Any shipment without an RMA number will not be accepted and will be returned to you at your expense. All authorized returned products must be accompanied with proof of purchase and a brief explanation of the problem.

For out-of-warranty repairs and service, please contact our Customer Service department for instructions. The repair shall be warranted for 90 days.

**IMPORTANT: YOUR RECEIPT IS PART OF YOUR WARRANTY AND MUST BE RETAINED AND PRODUCED IN THE EVENT OF A WARRANTY CLAIM.**

## Accessories

Please visit the ClearSounds website or call ClearSounds for additional accessories.



CS-CLA7V2 **neckloop** connects to your phone's 2.5 mm  jack for hands-free conversation.

Requires hearing aid(s) or cochlear implant(s) with t-coil(s).



CS-HD-500 headset connects to your phone's 2.5 mm  jack for hands-free conversation.

## Service

Customer Service in United States and Canada

Do you need some help? Please call, we are happy to assist you!

ClearSounds Communications

Attention: Repair Center

1743 Quincy Avenue, Suite 155

Naperville, IL 60540

USA

1-800-965-9043 (Toll-free)

[www.ClearSounds.com](http://www.ClearSounds.com)



© 2013 ClearSounds  
CS-A500/500EUG Ver 1